



**2019**

CYCLAMEN  
ASTER E CELOSIA  
CHRYSANTHEMUM  
HYDRANGEA MACROPHYLLA  
POINSETTIA





## LA STORIA

Sentier nasce nel 1980 come azienda di ortaggi e piante da vaso finite.

Negli anni '90 inizia a specializzarsi nella produzione di giovani piante. Nel 2000 comincia a sviluppare un lavoro di ricerca sul ciclamino, proseguendo con le piante vegetative. Nel 2009 Sentier introduce sul mercato le sue linee di Verbene ibride: Liga, Shangri-La ed Eden.

Per il prossimo futuro, in aggiunta a Prince F1 (Ciclamino frangiato, tetraploide), Sentier conta di introdurre sul mercato altre nuove linee di Ciclamino.

Attualmente l'azienda, sotto la guida dei titolari Michele Silvestrin e Romano Contessotto, è diventata un marchio di qualità e affidabilità, ed è una delle più importanti aziende del panorama italiano.

## IN CIFRE

- 8 ettari di area produttiva, di cui 3 dedicati a serre in vetro
- 55 000 000 il numero di piante prodotte, di cui il 75% destinate al mercato italiano
- più di 16 venditori italiani e 15 collaboratori europei
- più di 80 dipendenti, impiegati in diversi reparti, inclusi tecnici e ricercatori

## IN FIGURES

- 8 hectares of production area, 3 dedicated to greenhouses in glass
- 55 000 000 of young plants produced, 75% of them for the Italian market
- more than 16 Italian sellers and 15 collaborators in Europe
- more than 80 employees engage in different departments, including technicians and researchers



Romano Contessotto  
OWNER



Michele Silvestrin  
OWNER  
COMMERCIAL DIRECTOR



Andrea Persona



David Bazzoni



Mattia Silvestrin

AREA  
COMMERCIALE



Arianna Contessotto



Jennifer De Faveri



Gabriella Sandrin

# L'AZIENDA SENTIER

LOGISTICA



Gabriele De Noni



Giovanni Polegato

PRODUZIONE



Sabrina Bolzonello



Stella Toscan



Francesca Spagnol



Ester Vendramini



Sonia De Mari



Maurizio Contessotto



Constantin Coscodan

## THE HISTORY

Sentier was born in 1980, as vegetable and pot finish plant company. In the 90s the company undertook the way of the specialisation in the production of young plants. In the 2000s it began to develop a research work, beginning on Cyclamen and afterwards in vegetative plants. From 2009 Sentier is introducing its Verbena series: Liga, Shangi-La and Eden.

In addition to Prince F1 (Fringed Cyclamen tetraploid), in the next future Sentier plans to introduce in the market other Cyclamen series. Today Sentier, leads from the owners Michele Silvestrin and Romano Contessotto, has become a benchmark of quality and reliability, and it's one of the most important companies in the Italian view.

AMMINISTRA-  
ZIONE



Roberta Baron



Marilena Pazzia



Angela Galateanu



PRODUZIONE  
ITALIANA  
DI ALTA QUALITÀ

CATALOGHI  
AGGIORNATI  
IN TEMPO REALE



**ORDINI  
ON-LINE**



**VISITATE  
IL NOSTRO SITO  
[www.sentier.it](http://www.sentier.it)**

**AREA DI  
COLTIVAZIONE  
E DIFESA**



PRODUZIONE  
ITALIANA  
DI ALTA QUALITÀ





**PORTE APERTE  
AUTUNNO  
INVERNO**



**NOI SIAMO SEMPRE IN CAMPO...  
LEADERS IN THE FIELD...**

**PORTE APERTE  
PRIMAVERA  
ESTATE**

**WEEK  
45  
4-8 NOVEMBRE  
2019**



# PORTE APERTE 5 - 9 NOVEMBRE 2018



...PER FARE UN FIORE...CI VUOLE SENTIER  
...TO MAKE A FLOWER...IT TAKES SENTIER



## LEGENDA CONTENITORI - TRAY

### SEMINIERA / TRAY 50

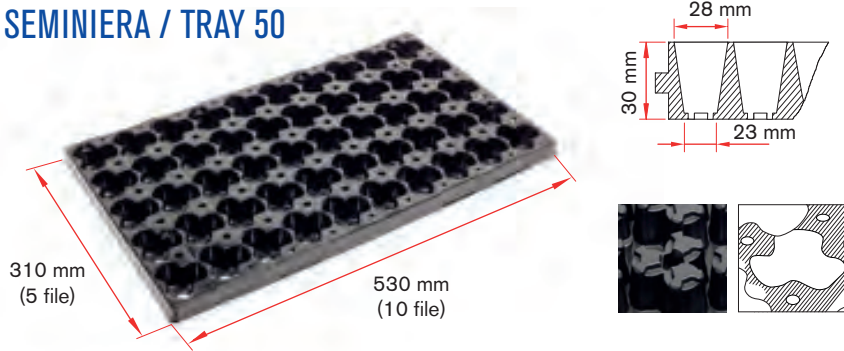

- DELOSPERMA JOD
- TRIOCRYSO
- TRIOMUSICALE

materiale: R PET  
material: R PET

### SEMINIERA / TRAY 60

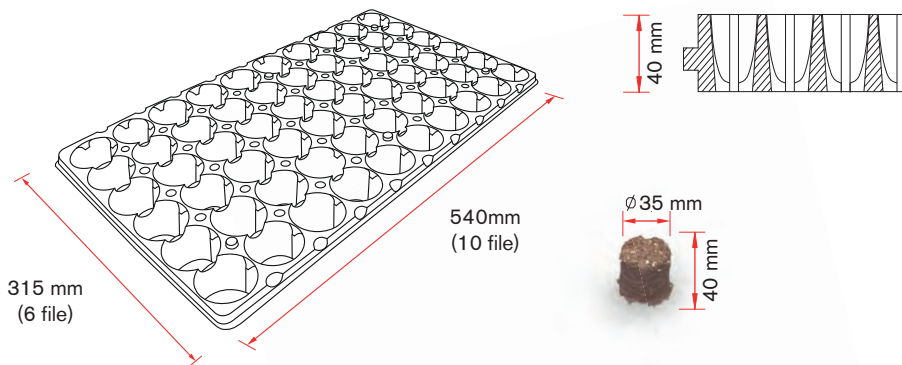

- ALSTROEMERIA
- EUPHORBIA PULCHERRIMA -  
POINSETTIA
- HYDRANGEA MACROPHYLLA -  
ORTENSIA

materiale: PS nero  
material: PS black

### CARDBOARD BOX - 60 PLANTS

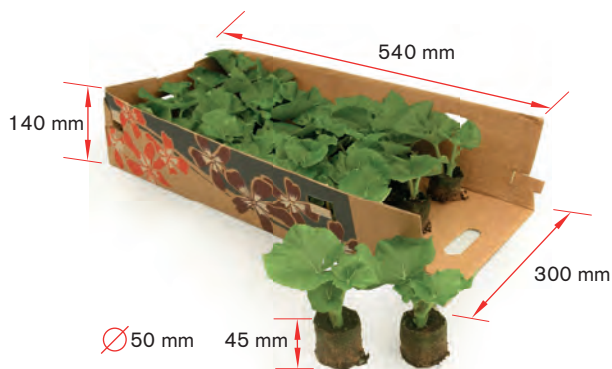

- BEGONIA ELATIOR - COLTIVATA IN  
JIFFY - GROWN IN JIFFY

materiale: cartone  
material: cardboard

## SEMINIERA / TRAY 66

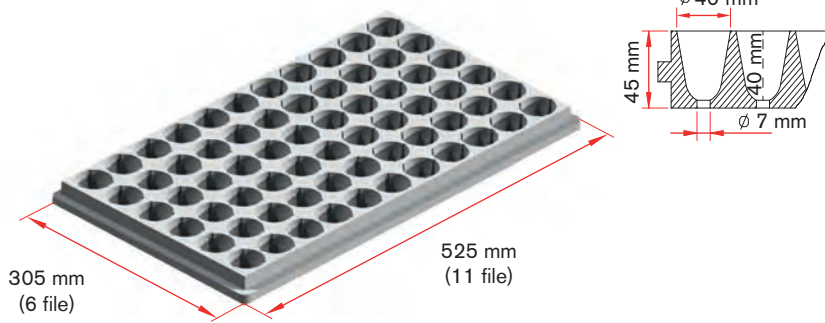

- CYCLAMEN PERSICUM

materiale: polistirolo espanso sinterizzato EPS bianco  
material: sintered expanded polystyrene EPS white

## SEMINIERA / TRAY 91

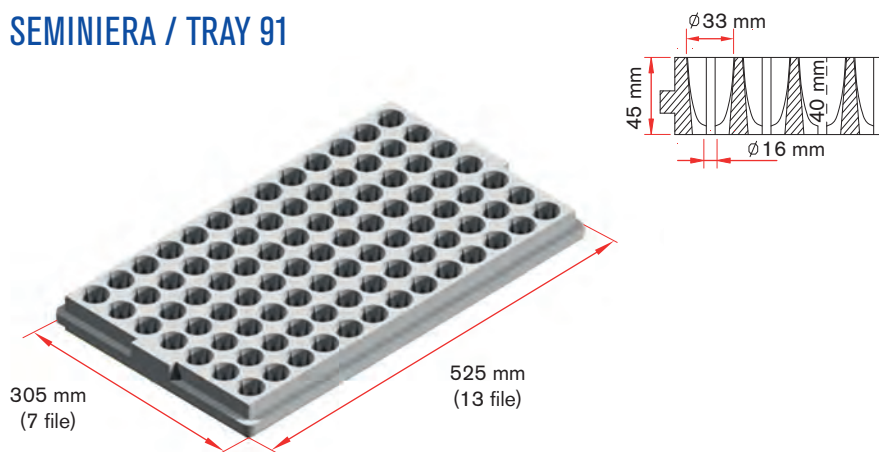

- CYCLAMEN PERSICUM
- PRIMULA OBCONICA

materiale: polistirolo espanso sinterizzato EPS bianco  
material: sintered expanded polystyrene EPS white

## SEMINIERA / TRAY 104

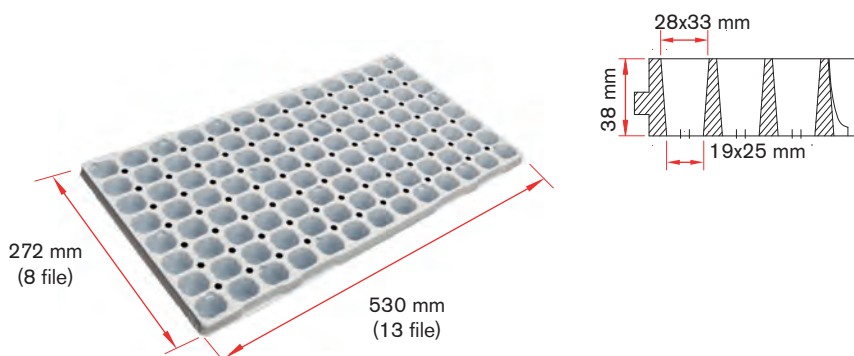

- CALCIOLARIA HYBRIDA
- CINERARIA HYBRIDA
- GERBERA JAMESONII
- RANUNCULUS ASIATICUS

materiale: R PET  
material: R PET

## LEGENDA CONTENITORI - TRAY

### SEMINIERA / TRAY 104

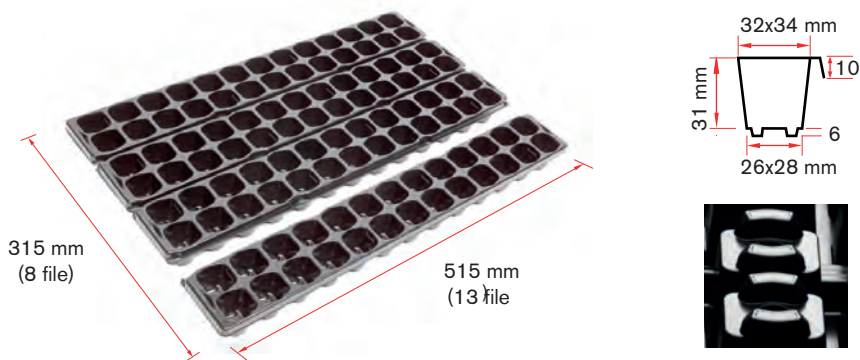

- DIANTHUS CARYOPHYLLUS
- IMPATIENS NEW GUINEA
- MANDEVILLA HYBRIDA
- PELARGONIUM

materiale: R PET  
material: R PET

### 2 STRIPS X 60 (120 TRAY)

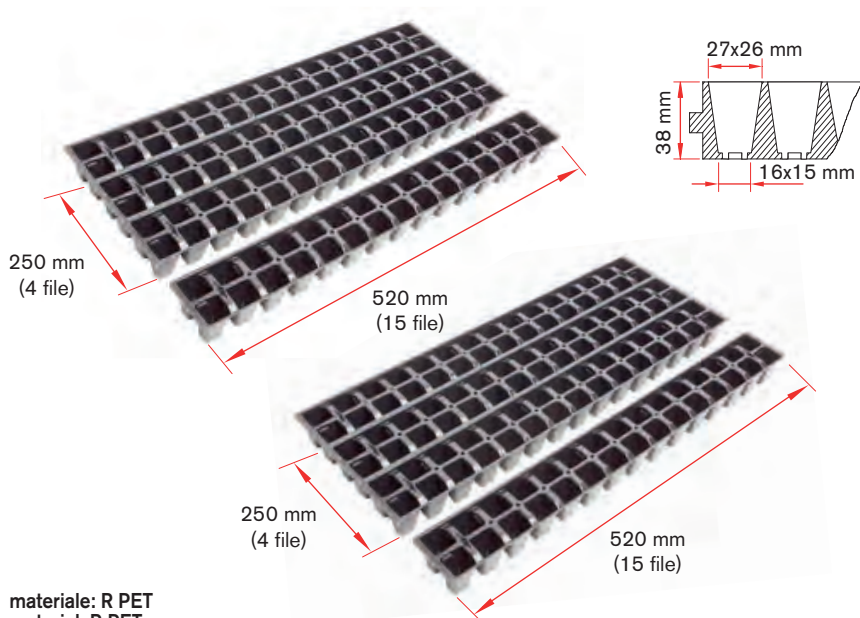

- ASTER NOVI-BELGII
- CELOSIA ARGENTEA
- HERBS FROM CUTTING - AROMATICHE DA TALEA
- GREEN LIFE
- CHRYSANTHEMUM 1 STRIP X 60
- PERENNIALS FROM CUTTING - PERENNI DA TALEA

materiale: R PET  
material: R PET

### SEMINIERA / TRAY 180

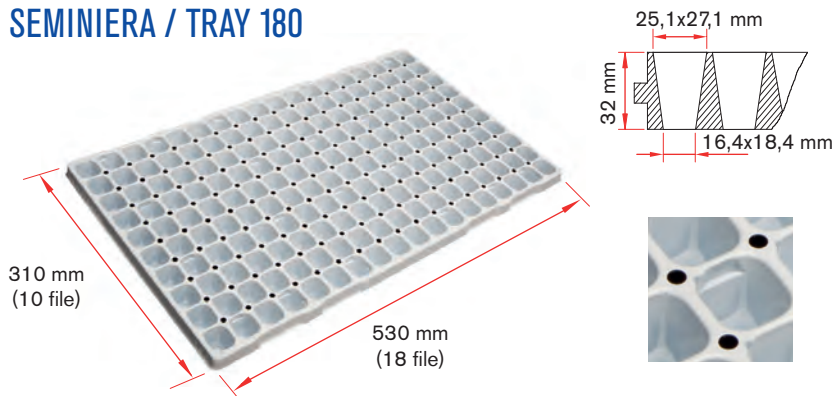

- BRASSICA OLERACEA - CAVOLO ORNAMENTALE
- GARDEN BEAUTY
- PERENNIALS FROM SEED - PERENNI DA SEME
- VIOLA HANGING
- VIOLA CONNYTRIO

materiale: R PET  
material: R PET

SEMINIERA / TRAY 264

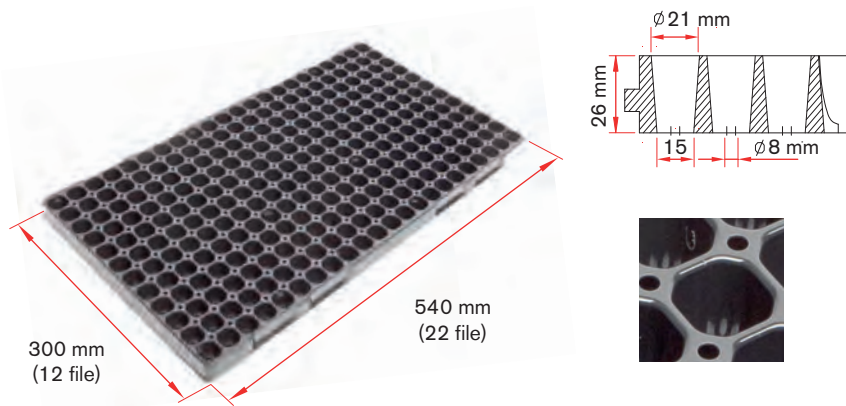

materiale: R PET  
material: R PET

- ANEMONE CORONARIA
- CYCLAMEN PERSICUM
- MATTHIOLA INCANA
- PRIMULA ACAULIS
- PRIMULA POLYANTHA
- MARAVILLA DELL'ORTO: PATIO EDIBLES - ORTO SUL TERRAZZO

SEMINIERA / TRAY 360

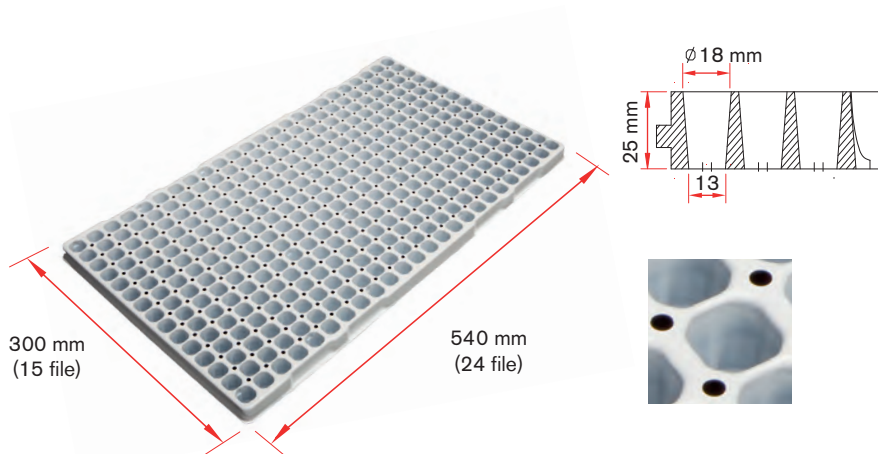

materiale: R PET  
material: R PET

- BEDDING PLANTS - ANNUALI
- BELLIS PERENNIS
- CUT FLOWERS - FIORI DA RECISO (LISIANTHUS)
- MARAVILLA DELL'ORTO: VEGETABLES - ORTO HOBBY
- MYOSOTIS SYLVATICA
- VIOLA WITTRUCKIANA
- VIOLA CORNUTA





01835 FORMULA HD RED REBELLE®



01281 FORMULA HD SALMON FLAME



01384 HALIOS® F1 MAGENTA FONCE



01101 HALIOS® F1 ROUGE REBELLE®



01637 HALIOS® F1 MÉLANGE FANTASIA®



01158 HALIOS® F1 CURLY® ÉCAR-LATE VIF



01279 HALIOS® F1 CURLY® LITCHI® FUCHSIA



01763 HALIOS® F1 CURLY® VIOLET VIF



01004 LATINIA® F1 SUCCESS® FUCHSIA NEON



01005 LATINIA® F1 SUCCESS® ROSE BONBON



01029 LATINIA® F1 SUCCESS® SAUMON FONCÉ



01841 LATINIA® F1 MÉLANGE SUCCESS® EVOL.



01288 LATINIA® FANTASIA® ROUGE EVOL.



01499 MAGNIA LIGHT ROSE EVOL.



01254 MAGNIA PINK



01409 WINTER ICE™ F1 LIGHT PURPLE FLAMED

# ANTEPRIMA NOVITÀ CYCLAMEN PERSICUM 2019



PAGINA  
**50**  
CYCLAMEN

**01040** INDIAKÄ® FUCHSIA



PAGINA  
**50**  
CYCLAMEN

**01041** INDIAKÄ® MAGENTA



PAGINA  
**50**  
CYCLAMEN

**01043** INDIAKÄ® SAUMON



PAGINA  
**50**  
CYCLAMEN

**01044** INDIAKÄ® VIOLET



PAGINA  
**74**  
CYCLAMEN

**00000** SUPER SERIE® DONATELLO®  
F1 CREAM WHITE



PAGINA  
**74**  
CYCLAMEN

**00000** SUPER SERIE® DONATELLO®  
F1 DARK VIOLET



PAGINA  
**74**  
CYCLAMEN

**00000** SUPER SERIE® DONATELLO®  
F1 DEEP WINE RED



PAGINA  
**74**  
CYCLAMEN

**00000** SUPER SERIE® DONATELLO®  
F1 NEON PINK



PAGINA  
**74**  
CYCLAMEN

**00000** SUPER SERIE® DONATELLO®  
F1 RED



PAGINA  
**74**  
CYCLAMEN

**00000** SUPER SERIE® DONATELLO®  
F1 SALMON WITH EYE



PAGINA  
**74**  
CYCLAMEN

**00000** SUPER SERIE® DONATELLO®  
F1 WINE RED FLAMED



PAGINA  
**74**  
CYCLAMEN

**01263** SUPER SERIE® DONATELLO®  
F1 MIXED



PAGINA  
**79**  
CYCLAMEN

**01920** SUPER SERIE® VERANO® F1  
VICTORIA SALMON





**38001** SHOWMAKERS® BABY PINK



**38002** SHOWMAKERS® BLUE BAYOU



**38003** SHOWMAKERS® FRESH PINK



**38004** SHOWMAKERS® MAGENTA



**38005** SHOWMAKERS® SNOW WHITE



**38006** TIARA® BLUE PARROT



**38007** TIARA® HOT PINK



**38009** TIARA® OPALE WHITE



**38010** TIARA® ROYAL PINK



**38011** TIARA® ROYAL PURPLE

## CELOSIA ARGENTEA 2019



**38012** FLIRT® LIME



**38013** FLIRT® MAGENTA



**38014** FLIRT® RED



**38016** HOT TOPIC® PINK



**38018** HOT TOPIC® RED



**38019** HOT TOPIC® YELLOW



**38020** MERIDA® PURPLE

## ANTEPRIMA NOVITÀ CHRYSANTHEMUM 2019



PAGINA  
**98**  
CHRYSANTHEMUM

**19363** FONTI DARK PINK



PAGINA  
**105**  
CHRYSANTHEMUM

**19364** MEFISTO ORANGE



PAGINA  
**107**  
CHRYSANTHEMUM

**19365** NAZIMI WHITE

## HYDRANGEA MACROPHYLLA - ORTENSIA 2019



PAGINA  
**125**  
ORTENSIA

**08204** SARENA BLUE



PAGINA  
**127**  
ORTENSIA

**08211** SARENA PINK



PAGINA  
**130**  
ORTENSIA

**08182** FRISBEE® PETTICOAT

## EUPHORBIA PULCHERRIMA - POINSETTIA 2019

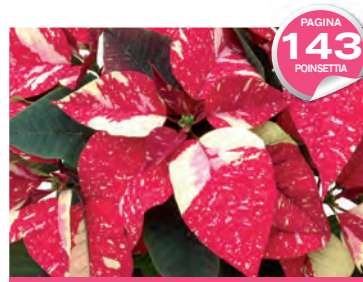

PAGINA  
**143**  
POINSETTIA

**29056** LAZZERI® SUPERBA GLITTER  
Lazzposugi



PAGINA  
**144**  
POINSETTIA

**29057** Astro Red®



PAGINA  
**144**  
POINSETTIA

**29058** Hera Red®



PAGINA  
**145**  
POINSETTIA

**29059** Leona Red®



PAGINA  
**145**  
POINSETTIA

**29060** Solar Red®

## LEGENDA

Disponibile in colori separati • Available in separated colours  
Disponibile en couleurs séparés



disponibilità  
availability  
disponible



ordine minimo contenitori  
minimum order  
quantité minimum

Qualità extra • Extra performance • Qualité extraordinaire



qualità extra  
extra performance  
qualité extraordinaire



preserie  
preserie  
présérie



experimental  
experimental  
expérimental

Crescita • Growth • Croissance



compatta  
compact  
compacte



medio-compatta  
medium-compact  
moyen compacte



vigorosa  
vigorous  
vigoureuse

Precocità • Precocity • Précocité



precoce  
early  
précoce



medio-precoce  
medium early  
moyen précoce



tardiva  
late  
tardive

Foglia • Leaf • Feuillage



verde  
green  
vert



argento  
silver  
marbrée

Tipo di fiore • Type of flower • Type de fleur



piccolo  
small  
petit



medio  
medium  
moyen



grande  
big  
grand

Utilizzo • Use • Emploi



Ø cm 6-10



Ø cm 10-12



Ø cm 12-18



Ø cm 14-18



---

CYCLAMEN  
PERSICUM

## CYCLAMEN PERSICUM - BIG FLOWER - THE TWIN

MAXI TWIN



CODICE	VARIETÀ	COLOUR	COLORE	DISP. IN COLORI SEPARATI O. EXTRA	CRESCITA	PRECOCITÀ	FOGLIA	TIPO DI FIORE	UTILIZZO
01924	BARCA	rouge et violet	rosso e viola	★ 4X66					14-18
01362	F. FUCHSIA - WHITE	fuchsia bic. et blanc	fuchsia bic. e bianco	★ 4X66					14-18
01909	F. MAGENTA - WHITE	magenta bic. et blanc	magenta bic. e bianco	★ 4X66					14-18
01363	F. RED - WHITE	rouge bic. et blanc	rosso bic. e bianco	★ 4X66					14-18
01910	F. VIOLET - WHITE	violet bic. et blanc	viola bic. e bianco	★ 4X66					14-18
01925	FUCHSIA - VIOLET	fuchsia et violet	fuchsia e viola	★ 4X66					14-18
01907	MAGENTA - WHITE	magenta et blanc	rosso porpora e bianco	★ 4X66					14-18
01956	SALMON - WHITE	saumon et blanc	salmone e bianco	★ 4X66					14-18
01926	SCARLET - WHITE	rouge écarlate et blanc	rosso e bianco	★ 4X66					14-18
01908	VIOLET - WHITE	violet et blanc	viola e bianco	★ 4X66					14-18



01924 BARCA



01362 F. FUCHSIA - WHITE



01909 F. MAGENTA - WHITE



01363 F. RED - WHITE

## THE TWIN - BIG FLOWER - CYCLAMEN PERSICUM



01910 F. VIOLET - WHITE



01925 FUCHSIA - VIOLET



01907 MAGENTA - WHITE



01956 SALMON - WHITE



01926 SCARLET - WHITE



01908 VIOLET - WHITE

## CYCLAMEN PERSICUM - BIG FLOWER

## RIVIERA F1



CODICE	VARIETÀ	COLOUR	COLORE	DISP. IN COLORI SEPARATI	Q. EXTRA	CRESCITA	PRECOCITÀ	FOGLIA	TIPO DI FIORE	UTILIZZO
01880	LIGHT PINK w. EYE	rose clair à oeil	rosa chiaro c/o	★ 4X66	●					14-18
01881	LILAC scented	lilas, parfumé	lilla profumato	★ 4X66	●					14-18
01882	PINK	rose	rosa	★ 4X66	●					14-18
01883	PURPLE scented	violet, parfumé	viola profumato	★ 4X66	●					14-18
01884	PURPLE FLAME	violet flammé	viola fiammato	★ 4X66	●					14-18
01896	SALMON	saumon	salmone	★ 4X66	●					14-18
01897	SCARLET	rouge écarlate	scarlatto	★ 4X66	●					14-18
01898	WHITE	blanc	bianco	★ 4X66	●					14-18
01899	WINE FLAME	pourpre flammé	rosso porpora fiammato	★ 4X66	●					14-18
01364	FANTASIA FUCHSIA	fuchsia bicouleur	fuchsia c/bordo bianco	★ 4X66						14-18
01903	FANTASIA MAGENTA	magenta bicouleur	rosso porpora c/bordo bianco	★ 4X66						14-18
01365	FANTASIA RED	rouge bicouleur	rosso c/bordo bianco	★ 4X66						14-18
01904	FANTASIA VIOLET	violet bicouleur	viola scuro c/bordo bianco	★ 4X66						14-18



01880 LIGHT PINK w. EYE



01883 PURPLE scented



01898 WHITE



01364 FANTASIA FUCHSIA



01903 FANTASIA MAGENTA



01365 FANTASIA RED



01904 FANTASIA VIOLET

## CHARISMA F1



CODICE	VARIETÀ	COLOUR	COLORE	DISP. IN COLORI SEPARATI	O. EXTRA	CRESCITA	PRECOCITÀ	FOGLIA	TIPO DI FIORE	UTILIZZO
01957	LIGHT PINK w. EYE	rose clair à oeil	rosa chiaro c/o	★						12-18
01764	LILAC scented	lilas, parfumé	lilla, profumato	★	●					12-18
01765	PINK	rose	rosa	★	●					12-18
01766	PURPLE scented	violet, parfumé	viola, profumato	★	●					12-18
01767	PURPLE FLAME	violet flammé	viola fiammato	★	●					12-18
01768	ROSE	rose	rosa	★	●					12-18
01769	SALMON	saumon	salmone	★	●					12-18
01770	SCARLET	rouge écarlate	scarlatto	★	●					12-18
01771	WHITE	blanc	bianco	★	●					12-18
01847	WHITE WITH EYE	blanc à oeil	bianco c/o	★						12-18
01846	WINE FLAME	rouge lie de vin	rosso vino fiammato	★						12-18
01848	FLAMED MIX	mélange flammé	fiammato mix	★	●					12-18
01636	MIXED	mélange	mix	★	●					12-18



01957 LIGHT PINK w. EYE



01764 LILAC, scented



01765 PINK



01766 PURPLE, scented



01767 PURPLE FLAME



01768 ROSE



01769 SALMON



01770 SCARLET



01771 WHITE



# CYCLAMEN PERSICUM - BIG FLOWER



01847 WHITE WITH EYE



01846 WINE FLAME



01848 FLAMED MIX



01636 MIXED

## PRINCE F1 (FRINGED) FRANGIATI



CODICE	VARIETÀ	COLOUR	COLORE	DISP. IN COLORI SEPARATI	O. EXTRA	CRESCITA	PRECOCITÀ	FOGLIA	TIPO DI FIORE	UTILIZZO
01690	DEEP ROSE	rose foncé	rosa carminio		●					12-18
01691	FUCHSIA	fuchsia	fuchsia							12-18
01692	LIGHT PINK w. EYE	rose clair à oeil	rosa chiaro c/o							12-18
01693	LILAC	lilas	lilla		●					12-18
01694	SALMON RED	rouge saumoné	rosso salmone		●					12-18
01695	SALMON ROSE	rose saumoné	rosa salmone		●					12-18
01696	WHITE w. EYE	blanc à oeil	bianco c/o		●					12-18
01319	VICTORIA MIX	victoria mélange	victoria mix	★ 3x91						12-18
01635	MIXED	mélange	mix	★ 3x91						12-18



01690 DEEP ROSE



01691 FUCHSIA



01692 LIGHT PINK w. EYE



01693 LILAC

DISPONIBILI SOLO IN MISCUGLIO - AVAILABLE ONLY IN MIX - DISPONIBLES SEULEMENT EN MÉLANGE



01694 SALMON RED



01695 SALMON ROSE



01696 WHITE w. EYE

DISPONIBILI SOLO IN MISCUGLIO - AVAILABLE ONLY IN MIX - DISPONIBLES SEULEMENT EN MÉLANGE



01319 VICTORIA MIX

## CYCLAMEN PERSICUM - BIG FLOWER

FORMULA HD

SENTIER'S  
SELECTION

CODICE	VARIETÀ	COLOUR	COLORE	DISP. IN COLORI SEPARATI	Q. EXTRA	CRESCITA	PRECOCITÀ	FOGLIA	TIPO DI FIORE	UTILIZZO
01102	BLUSH INTENSE (HD type)	blush intense	ton. magenta intenso e viola sfumato bianco	★						12-18
01610	HD BRIGHT ROSE	rose indien	fuchsia chiaro	★						12-18
01338	HD BRIGHT SCARLET	écarlate vif	scarlatto vivo	★	●					12-18
01928	HD DEEP MAGENTA	magenta foncé	rosso vino scuro	★	●					12-18
01547	HD DHIVA PURPLE	DHIVA violet foncé	DHIVA viola scuro							12-18
01889	HD GRENADINE	grenadine	rosa granata	★	●					12-18
01550	HD LIGHT ROSE	fuchsia clair	fuchsia chiaro	★	●					12-18
01053	HD LILAC	violet cattleya	lilla chiaro	★						12-18
01927	HD NEON ROSE	fuchsia neon	fuchsia neon	★	●					12-18
01309	HD PURE WHITE	blanc pur	bianco puro (precoce)	★						12-18
01835	HD RED REBELLE®	rouge rebelle	rosso vivo	★						12-18
01551	HD SALMON	saumon	salmone	★	●					12-18
01281	HD SALMON FLAME	saumon flammé	salmone fiammato	★	●					12-18
01929	HD SALMON ROSE	rose saumoné	rosa salmone	★	●					12-18
01553	HD SCARLET SALMON	saumon écarlate	rosso salmone	★	●					12-18
01099	HD WHITE	blanc	bianco	★	●					12-18
01059	HD FLAMED MIX	mélange flammé	fiammato mix	★	●					12-18
01670	HD MIXED	mélange	mix compatto	★	●					12-18
01632	PURPLE (HD type)	violet foncé	viola scuro	★	●					12-18
01890	RED silver leaf (HD type)	rouge décora	rosso f. decora	★	●					12-18
01049	SUPER RED (HD type)	rouge	rosso	★	●					12-18
01172	VICTORIA 50 ROSE WITH EYE (HD type)	victoria 50 rose à oeil	rosa c/o b.do rosso frang.	★						12-18
01253	FLAMED MIXED silver leaf (HD type)	mélange flammé décora	fiammato mix decora	★	●					12-18



01102 BLUSH INTENSE (HD type)



01610 HD BRIGHT ROSE



01338 HD BRIGHT SCARLET

## BIG FLOWER - CYCLAMEN PERSICUM



01928 HD DEEP MAGENTA



01547 HD DHIVA PURPLE

Disponibili solo in miscuglio - Available only in mix  
Disponibles seulement en mélange



01889 HD GRENADINE



01550 HD LIGHT ROSE



01053 HD LILAC



01927 HD NEON ROSE



01309 HD PURE WHITE



01835 HD RED REBELLE®



01551 HD SALMON



01281 HD SALMON FLAME



01929 HD SALMON ROSE



01553 HD SCARLET SALMON

## CYCLAMEN PERSICUM - BIG FLOWER



01099 HD WHITE



01059 HD FLAMED MIX



01632 PURPLE (HD type)



01670 HD MIXED



01890 RED SILVER LEAF (HD type)



01049 SUPER RED (HD type)



01172 VICTORIA 50 ROSE WITH EYE (HD type)



01253 FLAMED MIXED SILVER LEAF (HD type)

HALIOS® F1



CODICE	VARIETÀ	COLOUR	COLORE	DISP. IN COLORI SEPARATI	O. EXTRA	CRESCITA	PRECOCITÀ	FOGLIA	TIPO DI FIORE	UTILIZZO
01051	BLANC À OEIL	white with eye	bianco c/o	★	●					12-18
01300	BLANC DÉCORA	white, silver leaf	bianco f. decora	★	●					12-18
01052	BLANC PUR ( ex compact)	pure white	bianco puro ( compatto)	★	●					12-18
01545	DHIVA BLANC PUR	DHIVA pure white	DHIVA bianco puro	★	●					12-18
01054	ÉCARLATE VIF	bright scarlet	scarlatto vivo	★	●					12-18
01055	FUCHSIA CLAIR	light rose	fuchsia chiaro	★	●					12-18
01056	FUCHSIA VIF	deep rose	fuchsia intenso	★	●					12-18
01368	FUNFLAME® MAGENTA	funflame magenta	bianco sfumato magenta	★						12-18
01057	MAGENTA	magenta	rosso porpora	★	●					12-18
01058	MAGENTA FLAMMÉ	magenta flame	rosso porpora fiammato	★	●					12-18
01384	MAGENTA FONCÉ	deep magenta	rosso porpora scuro	★	●					12-18
01307	ROSE À OEIL	rose with eye	rosa c/o	★	●					12-18
01062	ROSE SAUMONÉ	salmon rose	rosa salmone	★	●					12-18
01063	ROUGE ÉCARLATE	scarlet red	rosso scarlatto	★						12-18
01101	ROUGE REBELLE®	red REBELLE®	rosso brillante	★						12-18
01978	SAUMON FLAMMÉ	salmon flame	salmone fiammato	★	●					12-18
01340	VICTORIA 50 SAUMON	victoria 50 salmon	rosa salmone bordo rosso	★	●					12-18
01501	VIOLET	light purple	viola	★	●					12-18
01066	VIOLET FLAMMÉ	purple flame	viola fiammato	★	●					12-18
01067	VIOLET FONCÉ (HD)	purple	viola scuro	★	●					12-18
01188	MÉLANGE classique	standard mix	mix classico	★	●					12-18



01051 BLANC À OEIL



01300 BLANC DÉCORA



01052 BLANC PUR



01545 DHIVA BLANC PUR



01054 ÉCARLATE VIF



01055 FUCHSIA CLAIR

## CYCLAMEN PERSICUM - BIG FLOWER



01056 FUCHSIA VIF



01368 FUNFLAME® MAGENTA



01057 MAGENTA



01058 MAGENTA FLAMMÉ



01384 MAGENTA FONCE



01307 ROSE À OEIL



01062 ROSE SAUMONÉ



01063 ROUGE ÉCARLATE



01101 ROUGE REBELLE®



01978 SAUMON FLAMMÉ



01340 VICTORIA 50 SAUMON



01501 VIOLET



01066 VIOLET FLAMMÉ



01067 VIOLET FONCÉ



01188 MÉLANGE classique



## CYCLAMEN PERSICUM - BIG FLOWER

## HALIOS® F1 FANTASIA®



CODICE	VARIETÀ	COLOUR	COLORE	DISP. IN COLORI SEPARATI	Q. EXTRA	CRESCITA	PRECOCITÀ	FOGLIA	TIPO DI FIORE	UTILIZZO
01608	FANTASIA® FUCHSIA	FANTASIA fuchsia	fuchsia c/ bordo bianco							12-18
01891	FANTASIA® FUCHSIA VIF	FANTASIA deep fuchsia	fuchsia vivo c/bordo bianco	★	●					12-18
01498	FANTASIA® MAGENTA	FANTASIA magenta	rosso porpora c/bordo bianco	★	●					12-18
01979	FANTASIA® MAGENTA DÉCORA	FANTASIA magenta, silver leaf	rosso porpora c/bordo bianco f. decora		●					12-18
01609	FANTASIA® ROUGE	FANTASIA red	rosso c/bordo bianco	★	●					12-18
01383	FANTASIA® VIOLET FONCÉ	FANTASIA purple	viola scuro c/bordo bianco	★	●					12-18
01980	FANTASIA® VIOLET FONCÉ DÉCORA	FANTASIA purple, silver leaf	viola scuro c/bordo bianco f. decora		●					12-18
01637	MÉLANGE FANTASIA®	FANTASIA mix	fantasia mix	★	●					12-18



01608 FANTASIA® FUCHSIA



01891 FANTASIA® FUCHSIA VIF



01498 FANTASIA® MAGENTA



01979 FANTASIA® MAGENTA DÉCORA



01609 FANTASIA® ROUGE



01383 FANTASIA® VIOLET FONCÉ



01980 FANTASIA® VIOLET FONCÉ DÉCORA



01637 MÉLANGE FANTASIA®

## CYCLAMEN PERSICUM - BIG FLOWER

## HALIOS® F1 CURLY® FRINGED (FRANGIATI)



CODICE	VARIETÀ	COLOUR	COLORE	DISP. IN COLORI SEPARATI	Q. EXTRA	CRESCITA	PRECOCITÀ	FOGLIA	TIPO DI FIORE	UTILIZZO
01548	CURLY® BLANC	CURLY white	bianco	★ 3x91	●					12-18
01797	CURLY® ÉCARLATE	CURLY scarlet	rosso scarlatto							12-18
01158	<b>NEW</b> CURLY® ÉCARLATE VIF	CURLY bright scarlet	rosso brillante	★ 3x91	●					12-18
01795	CURLY® FUCHSIA	CURLY fuchsia	fuchsia							12-18
01389	CURLY® FUCHSIA CLAIR exp	CURLY light fuchsia	fuchsia chiaro							12-18
01796	CURLY® FUCHSIA CLAIR & FLAMMÉ	CURLY light fuchsia and flamed	fuchsia chiaro e fiammato							12-18
01895	CURLY® FUCHSIA VIF	CURLY deep fuchsia	fuchsia intenso							12-18
01279	<b>NEW</b> CURLY® LITCHI® FUCHSIA	CURLY LITCHI® rose	rosa bordato	★ 3x91	●					12-18
01798	CURLY® MAGENTA	CURLY magenta	rosso porpora		●					12-18
01390	CURLY® MAGENTA FLAMMÉ exp.	CURLY magenta flamed	magenta fiammato							12-18
01892	CURLY® MAGENTA LISERÉ	CURLY magenta with edge	rosso porp. c/bordo bianco							12-18
01799	CURLY® ROSE CLAIR À OEIL ROUGE	CURLY light pink with red eye	rosa chiaro con occhio rosso	★ 3x91	●					12-18
01393	CURLY® ROSE CLAIR À OEIL VIOLET exp.	CURLY light pink with purple eye	rosa chiaro con occhio viola							12-18
01800	CURLY® ROSE SAUMONÉ & FLAMMÉ	CURLY salmon rose and flamed	rosa salmone e sfumato							12-18
01894	CURLY® SAUMON ÉCARLATE	CURLY scarlet salmon	rosso salmone							12-18
01392	CURLY® VIOLET FLAMMÉ exp.	CURLY violet flamed	viola fiammato							12-18
01893	CURLY® VIOLET FONCÉ	CURLY purple	viola scuro							12-18
01763	<b>NEW</b> CURLY® VIOLET VIF	CURLY bright purple	viola brillante	★ 3x91	●					12-18
01801	CURLY® VIOLET LISERÉ	CURLY purple with edge	viola c/bordo bianco							12-18
01371	CURLY® MÉLANGE FLAMMÉ	CURLY flamed mix	fiammato mix	★ 3x91	●					12-18
01760	CURLY® MÉLANGE PREC. EVOL.	CURLY mix early	frangiato mix precoce evol.	★ 3x91	●					12-18
01949	CURLY® MÉLANGE	CURLY mix	frangiato mix	★ 3x91	●					12-18



01548 CURLY® BLANC



01797 CURLY® ÉCARLATE



01158 CURLY® ÉCARLATE VIF

## BIG FLOWER - CYCLAMEN PERSICUM



01795 CURLY® FUCHSIA



01796 CURLY® FUCHSIA CLAIR &amp; FLAMMÉ



01895 CURLY® FUCHSIA VIF



01279 CURLY® LITCHI® FUCHSIA

01798 CURLY® MAGENTA  
Disponibili solo in miscuglio - Available only in mix  
Disponibles seulement en mélange01390 CURLY® MAGENTA FLAMMÉ exp.  
Disponibili solo in miscuglio - Available only in mix  
Disponibles seulement en mélange

01892 CURLY® MAGENTA LISERÉ



01799 CURLY® ROSE CLAIR À OEIL ROUGE



01800 CURLY® ROSE SAUMONÉ &amp; FLAMMÉ



01894 CURLY® SAUMON ÉCARLATE



01893 CURLY® VIOLET FONCÉ



01763 CURLY® VIOLET VIF

## CYCLAMEN PERSICUM - BIG FLOWER



01801 CURLY® VIOLET LISERÉ



01371 CURLY® MÉLANGE FLAMMÉ



01760 CURLY® MÉLANGE PRÉC. EVOL.

## LATINIA® F1



CODICE	VARIETÀ	COLOUR	COLORE	DISP. IN COLORI SEPARATI O. EXTRA	CRESCITA	PRECOCITÀ	FOGLIA	TIPO DI FIORE	UTILIZZO
01451	FUNFLAME® MAGENTA	funflame magenta	bianco sfumato magenta	★					12-18
01505	MÉLANGE FLAMMÉ	flamed mix	mix fiammato	★					12-18



01451 FUNFLAME® MAGENTA



01505 MÉLANGE FLAMMÉ

## LATINIA® F1 SUCCESS®



CODICE	VARIETÀ	COLOUR	COLORE	DISP. IN COLORI SEPARATI	Q. EXTRA	CRESCITA	PRECOCITÀ	FOGLIA	TIPO DI FIORE	UTILIZZO
01803	SUCCESS® BLANC PUR	SUCCESS pure white	bianco puro	★	●					12-18
01805	SUCCESS® FUCHSIA	SUCCESS fuchsia	fuchsia	★	●					12-18
01004	<b>NEW</b> SUCCESS® FUCHSIA NEON	SUCCESS fuchsia neon	fuchsia neon	★						12-18
01806	SUCCESS® MAGENTA FONCÉ	SUCCESS deep magenta	rosso porpora intenso	★	●					12-18
01005	<b>NEW</b> SUCCESS® ROSE BONBON	SUCCESS candy pink	rosa con occhio violetto	★						12-18
01639	SUCCESS® ROUGE VIF	SUCCESS bright red	rosso vivo	★	●					12-18
01807	SUCCESS® SAUMON	SUCCESS salmon	salmone	★	●					12-18
01029	<b>NEW</b> SUCCESS® SAUMON FONCÉ	SUCCESS deep salmon	salmone scuro	★						12-18
01888	SUCCESS® VIOLET	SUCCESS purple	viola	★	●					12-18
01841	<b>NEW</b> MÉLANGE SUCCESS® EVOL.	SUCCESS mix evolution	success mix evol.	★	●					12-18



01803 SUCCESS® BLANC PUR



01805 SUCCESS® FUCHSIA



01004 SUCCESS® FUCHSIA NEON



01806 SUCCESS® MAGENTA FONCÉ



01005 SUCCESS® ROSE BONBON



01639 SUCCESS® ROUGE VIF



01807 SUCCESS® SAUMON



01029 SUCCESS® SAUMON FONCÉ



01888 SUCCESS® VIOLET

## CYCLAMEN PERSICUM - BIG FLOWER



01841 MÉLANGE SUCCESS® EVOL.

## LATINIA® F1 FANTASIA®



CODICE	VARIETÀ	COLOUR	COLORE	DISP. IN COLORI SEPARATI	Q. EXTRA	CRESCITA	PRECOCITÀ	FOGLIA	TIPO DI FIORE	UTILIZZO
01502	FANTASIA® CATTLEYA	FANTASIA lilac	lilla c/bordo bianco							12-18
01503	FANTASIA® FUCHSIA	FANTASIA rose	fuchsia c/bordo bianco							12-18
01450	FANTASIA® FUCHSIA VIF	FANTASIA deep rose	fuchsia vivo c/bordo bianco							12-18
01641	FANTASIA® MAGENTA FONCÉ	FANTASIA deep magenta	rosso porpora c/bordo bianco							12-18
01288	FANTASIA® ROUGE EVOL.	FANTASIA red evolution	rosso c/bordo bianco							12-18
01504	FANTASIA® VIOLET FONCÉ	FANTASIA purple	viola scuro c/bordo bianco							12-18
01761	MÉLANGE FANTASIA®	FANTASIA mixed	mix fantasia	★ 3x91	●					12-18

Latinia® Fantasia ha il fiore più piccolo di tutta la serie - Latinia® Fantasia has the flower smallest than all the series. - Latinia® Fantasia a le fleur le plus petit de tout la gamme.



01502 FANTASIA® CATTLEYA



01503 FANTASIA® FUCHSIA



01450 FANTASIA® FUCHSIA VIF



01641 FANTASIA® MAGENTA FONCÉ



01288 FANTASIA® ROUGE EVOL.



01504 FANTASIA® VIOLET FONCÉ



01761 MÉLANGE FANTASIA®



## CYCLAMEN PERSICUM - BIG FLOWER

## MAGNIA



CODICE	VARIETÀ	COLOUR	COLORE	DISP. IN COLORI SEPARATI	Q. EXTRA	CRESCITA	PRECOCITÀ	FOGLIA	TIPO DI FIORE	UTILIZZO
01262	DEEP ROSE LIGHT EDGE	rose foncé liseré	rosa scuro c/bordo chiaro	★						12-18
01266	LIGHT PINK EYE	rose clair à oeil	rosa chiaro c/o	★						12-18
01499	<b>NEW</b> LIGHT ROSE	rose clair	rosa chiaro	★						12-18
01254	<b>NEW</b> PINK	rose	rosa	★						12-18
01267	DEEP PURPLE	violet foncé	viola scuro	★						12-18
01268	RED	rouge	rosso	★						12-18
01321	SALMON EYE	saumon à oeil	salmone c/o	★						12-18
01269	WHITE	blanc	bianco	★						12-18
01678	MIXED	mélange	mix	★						12-18



01262 DEEP ROSE LIGHT EDGE



01266 LIGHT PINK EYE



01499 LIGHT ROSE



01254 PINK



01267 DEEP PURPLE



01268 RED



01321 SALMON EYE



01269 WHITE



PANORAMICA AZIENDA SENTIER - VIEW OF COMPANY SENTIER

## CYCLAMEN PERSICUM - BIG FLOWER

## SUPER SERIE® MAMMOTH® F1



CODICE	VARIETÀ	COLOUR	COLORE	DISP. IN COLORI SEPARATI	Q. EXTRA	CRESCITA	PRECOCITÀ	FOGLIA	TIPO DI FIORE	UTILIZZO
01852	CREAM WHITE	blanc crème	bianco crema	★	●					14-18
01853	DARK VIOLET	violet foncé	viola scuro	★	●					14-18
01624	LIGHT SALMON PINK	saumon clair	salmone chiaro	★	●					14-18
01626	NEON FLAMED	rose neon flammé	rosa neon fiammato	★	●					14-18
01855	NEON PINK	rose neon	rosa neon	★	●					14-18
01249	ORCHID	orchid	orchidea	★	●					14-18
01856	RED	rouge	rosso	★	●					14-18
01960	SALMON FLAMED	saumon flammé	salmone fiammato	★	●					14-18
01932	VIOLET FLAMED	violet flammé	viola fiammato		●					14-18
01750	WINE RED	rouge lie de vin	rosso vino	★	●					14-18
01625	WINE RED FLAMED	rouge lie de vin flammé	rosso vino fiammato	★	●					14-18
01857	FLAMED MIX	mélange flammé	fiammato mix	★	●					14-18
01727	MIXED	mélange	mix	★	●					14-18



01852 CREAM WHITE



01853 DARK VIOLET



01624 LIGHT SALMON PINK



01626 NEON FLAMED

## BIG FLOWER - CYCLAMEN PERSICUM



01855 NEON PINK



01249 ORCHID



01856 RED



01960 SALMON FLAMED



01932 VIOLET FLAMED



01750 WINE RED



01625 WINE RED FLAMED



01857 FLAMED MIX

## CYCLAMEN PERSICUM - BIG FLOWER

## SUPER SERIE® XL® F1



CODICE	VARIETÀ	COLOUR	COLORE	DISP. IN COLORI SEPARATI	Q. EXTRA	CRESCITA	PRECOCITÀ	FOGLIA	TIPO DI FIORE	UTILIZZO
01775	CREAM WHITE	blanc crème	bianco crema							12-18
01507	DARK SALMON PINK	rose saumoné foncé	rosa salmone scuro							12-18
01508	DARK VIOLET IMPR.	violet foncé	viola scuro		●					12-18
01644	LIGHT SALMON PINK IMPR.	saumon clair	salmone chiaro							12-18
01509	LIGHT VIOLET	violet clair	viola chiaro		●					12-18
01580	LIGHT w. EYE	blanc rosé à oeil	bianco rosato c/o							12-18
01511	NEON FLAMED	rose neon flammé	rosa neon fiammato		●					12-18
01512	NEON PINK	rose neon	rosa neon		●					12-18
01645	ORCHID	lilas fuchsia	orchidea							12-18
01513	PURE WHITE	blanc pur	bianco puro	★ 3X91	●					12-18
01514	RED	rouge	rosso	★ 3X91	●					12-18
01515	SALMON FLAMED	saumon flammé	salmone fiammato		●					12-18
01516	VIOLET FLAMED	violet flammé	viola fiammato		●					12-18
01582	WINE RED	rouge lie de vin	rosso vino		●					12-18
01518	WINE RED FLAMED	rouge lie de vin flammé	rosso vino fiammato		●					12-18
01345	FLAMED MIX	mélange flammé	fiammato mix	★ 3X91	●					12-18
01258	MIXED	mélange	mix	★ 3X91	●					12-18



01775 CREAM WHITE



01507 DARK SALMON PINK



01508 DARK VIOLET IMPR.



01644 LIGHT SALMON PINK IMPR.



01509 LIGHT VIOLET



01580 LIGHT w. EYE

# BIG FLOWER - CYCLAMEN PERSICUM



01511 NEON FLAMED



01512 NEON PINK



01645 ORCHID



01513 PURE WHITE



01514 RED



01515 SALMON FLAMED



01516 VIOLET FLAMED



01582 WINE RED



01518 WINE RED FLAMED



01345 FLAMED MIX

## CYCLAMEN PERSICUM - BIG FLOWER

## SUPER SERIE® XL® F1 FUJI



CODICE	VARIETÀ	COLOUR	COLORE	DISP. IN COLORI SEPARATI	Q. EXTRA	CRESCITA	PRECOCITÀ	FOGLIA	TIPO DI FIORE	UTILIZZO
01248	FUJI RED IMPR.	rouge bicouleur	rosso c/bordo bianco	★ 3X91	●					12-18
01408	FUJI WINE RED	rouge lie de vin bicouleur	rosso vino c/bordo bianco							12-18



01248 FUJI RED



01408 FUJI WINE RED

Disponibili solo in miscuglio - Available only in mix - Disponibles seulement en mélange

## WINTER ICE™ F1



CODICE	VARIETÀ	COLOUR	COLORE	DISP. IN COLORI SEPARATI	Q. EXTRA	CRESCITA	PRECOCITÀ	FOGLIA	TIPO DI FIORE	UTILIZZO
01409	LIGHT PURPLE FLAMED	violet clair flammé	viola chiaro fiammato	★ 3X91	●					12-18
01776	SCARLET	rouge écarlate	rosso	★ 3X91	●					12-18
01579	WHITE	blanc	bianco	★ 3X91	●					12-18



01409 LIGHT PURPLE FLAMED



01776 SCARLET



01579 WHITE

## SNOWRIDGE MAXI F1



CODICE	VARIETÀ	COLOUR	COLORE	DISP. IN COLORI SEPARATI	O. EXTRA	CRESCITA	PRECOCITÀ	FOGLIA	TIPO DI FIORE	UTILIZZO
01954	MAXI PURPLE	violet bicouleur	viola c/bordo bianco	★ 3X91	●					12-18
01375	MAXI ROSE	rose bicouleur	rosa c/bordo bianco	★ 3X91	●					12-18
01376	MAXI SCARLET	rouge bicouleur	rosso scarlatto c/bordo bianco	★ 3X91	●					12-18
01159	MAXI WINE	rouge lie de vin bicouler	rosso vino c/bordo bianco	★ 3X91	●					12-18



01954 MAXI PURPLE



01375 MAXI ROSE



01376 MAXI SCARLET



01159 MAXI WINE



SENTIER: TRAPIANTO DI GIOVANI PIANTE DI CICLAMINO - TRANSPLANT OF CYCLAMEN'S YOUNG PLANTS



**CYCLAMEN PERSICUM**

SENTIER: SERRE DI COLTIVAZIONE DI CICLAMINI - SENTIER'S GREENHOUSES CULTIVATION OF CYCLAMEN YOUNG PLANTS



## CYCLAMEN PERSICUM - MIDI FLOWER

INDIAKA®



CODICE	VARIETÀ	COLOUR	COLORE	DISP. IN COLORI SEPARATI	Q. EXTRA	CRESCITA	PRECOCITÀ	FOGLIA	TIPO DI FIORE	UTILIZZO
01040	<b>NEW</b> FUCHSIA	fuchsia/white	fuchsia/bianco	★ 3X91	●					10-12
01041	<b>NEW</b> MAGENTA	magenta/white	rosso porpora/bianco	★ 3X91	●					10-12
01043	<b>NEW</b> SAUMON	salmon/white	salmone/bianco	★ 3X91	●					10-12
01044	<b>NEW</b> VIOLET	purple/white	viola/bianco	★ 3X91	●					10-12

**NEW**

01040 FUCHSIA

**NEW**

01041 MAGENTA

**NEW**

01043 SAUMON

**NEW**

01044 VIOLET

## PREMIUM F1



CODICE	VARIETÀ	COLOUR	COLORE	DISP. IN COLORI SEPARATI	Q. EXTRA	CRESCITA	PRECOCITÀ	FOGLIA	TIPO DI FIORE	UTILIZZO
01114	SAUMON FLAMMÉ parfumé	salmon flame	salmone fiammato , profumato	★ 3X91	●					10-12
01643	MÉLANGE FLAMMÉ LISERÉ	flamed mix	fiammato mix	★ 3X91	●					10-12



01114 SAUMON FLAMMÉ parfumé



01643 MÉLANGE FLAMMÉ LISERÉ

## SUPER SERIE® ALLURE® F1



CODICE	VARIETÀ	COLOUR	COLORE	DISP. IN COLORI SEPARATI	Q. EXTRA	CRESCITA	PRECOCITÀ	FOGLIA	TIPO DI FIORE	UTILIZZO
01402	CREAM WHITE	blanc crème	bianco crema	★						10-12
01698	DARK SALMON PINK	rose saumon foncé	rosa salmone scuro	★	●					10-12
01699	DARK VIOLET	violet foncé	viola scuro	★	●					10-12
01779	DEEP SALMON FLAMED	saumon foncé flammé	salmone intenso fiammato	★	●					10-12
01742	LAVENDER	lavande	lavanda	★						10-12
01777	LIGHT NEON PINK IMPR.	rose clair neon	rosa chiaro neon		●					10-12
01778	LIGHT SALMON PINK	rose saumon clair	rosa salmone chiaro	★	●					10-12
01700	LIGHT VIOLET	violet clair	viola chiaro	★	●					10-12
01701	NEON FLAMED	rose neon flammé	rosa neon fiammato	★	●					10-12
01672	NEON PINK IMPR.	rose neon	rosa neon	★	●					10-12
01679	PURE WHITE	blanc pur	bianco puro	★	●					10-12
01667	RED	rouge	rosso	★	●					10-12
01702	VIOLET FLAMED IMPR.	violet flammé	viola fiammato	★	●					10-12
01686	WHITE WITH EYE	blanc à oeil	bianco c/o	★						10-12
01703	WINE RED	rouge lie de vin	rosso vino	★	●					10-12
01704	WINE RED FLAMED	rouge lie de vin flammé	rosso vino fiammato	★	●					10-12
01682	FLAMED MIX	mélange flammé	fiammato mix	★	●					10-12
01631	MIXED	mélange	mix	★	●					10-12



01402 CREAM WHITE



01698 DARK SALMON PINK



01699 DARK VIOLET



01779 DEEP SALMON FLAMED



01742 LAVENDER



01777 LIGHT NEON PINK IMPR.

## CYCLAMEN PERSICUM - MIDI FLOWER



**01778** LIGHT SALMON PINK



**01700** LIGHT VIOLET



**01701** NEON FLAMED



**01672** NEON PINK IMPR.



**01679** PURE WHITE



**01667** RED



**01702** VIOLET FLAMED IMPR.



**01686** WHITE w. EYE



**01703** WINE RED



**01704** WINE RED FLAMED



**01682** FLAMED MIX



01631 MIXED

## SUPER SERIE® ALLURE® F1 FUJI



CODICE	VARIETÀ	COLOUR	COLORE	DISP. IN COLORI SEPARATI	Q. EXTRA	CRESCITA	PRECOCITÀ	FOGLIA	TIPO DI FIORE	UTILIZZO
01633	FUJI DARK VIOLET	violet foncé bicouleur	viola c/bordo bianco	★ 3X91	●					10-12
01194	FUJI NEON PINK	rose neon bicouleur	rosa neon c/bordo bianco	★ 3X91	●					10-12
01134	FUJI RED	rouge bicouleur	rosso c/bordo bianco	★ 3X91	●					10-12
01677	FUJI WINE RED	rouge lie de vin bicouleur	rosso vino c/bordo bianco	★ 3X91	●					10-12
01265	ALLURE FUJI MIX	mélange bicouleur	mix c/bordo bianco	★ 3X91	●					10-12



01633 FUJI DARK VIOLET



01194 FUJI NEON PINK



01134 FUJI RED



01677 FUJI WINE RED



01265 ALLURE® FUJI MIX

## CYCLAMEN PERSICUM - MIDI FLOWER

## SUPER SERIE® MACRO F1



CODICE	VARIETÀ	COLOUR	COLORE	DISP. IN COLORI SEPARATI	O. EXTRA	CRESCITA	PRECOCITÀ	FOGLIA	TIPO DI FIORE	UTILIZZO
01858	CREAM WHITE	blanc crème	bianco crema							10-12
01647	DARK SALMON PINK	rose saumon foncé	rosa salmone scuro		●					10-12
01521	DARK VIOLET IMPR.	violet foncé	viola scuro							10-12
01247	LAVENDER	lavande	lavanda							10-12
01522	LIGHT SALMON PINK	rose saumon clair	rosa salmone chiaro							10-12
01523	LIGHT VIOLET	violet clair	viola chiaro							10-12
01860	LIGHT WITH EYE	blanc rose à oeil	bianco rosato c/o		●					10-12
01524	NEON FLAMED	rose neon flammé	rosa neon fiammato		●					10-12
01525	NEON PINK	rose neon	rosa neon		●					10-12
01861	PINK WITH EYE	rose à oeil	rosa chiaro c/o		●					10-12
01583	PURE WHITE	blanc pur	bianco puro		●					10-12
01526	RED	rouge	rosso		●					10-12
01527	SALMON FLAMED IMPR.	saumon flammé	salmone fiammato		●					10-12
01528	VIOLET FLAMED	violet flammé	viola fiammato		●					10-12
01531	WINE RED	rouge lie de vin	rosso vino		●					10-12
01532	WINE RED FLAMED	rouge lie de vin flammé	rosso vino fiammato		●					10-12
01460	FLAMED MIX	mélange flammé	fiammato mix	★ 3X91 1X264	●					10-12
01103	MIXED	mélange	mix	★ 3X91 1X264	●					10-12



01460 FLAMED MIX



01103 MIXED

## SUPER SERIE® MACRO F1 FUJI



CODICE	VARIETÀ	COLOUR	COLORE	DISP. IN COLORI SEPARATI	Q. EXTRA	CRESCITA	PRECOCITÀ	FOGLIA	TIPO DI FIORE	UTILIZZO
01165	FUJI DARK VIOLET	violet foncé bicouleur	viola scuro c/bordo bianco							10-12
01164	FUJI NEON PINK	rose neon bicouleur	rosa neon c/bordo bianco							10-12
01125	FUJI RED	rouge bicouleur	rosso c/bordo bianco							10-12
01157	FUJI SALMON	saumon bicouleur	salmone c/bordo bianco							10-12
01259	FUJI WINE RED	rouge lie de vin bicouleur	rosso vino c/bordo bianco							10-12
01200	MACRO FUJI MIX	mélange bicouleur	mix c/bordo bianco	★ 3X91						10-12



01165 FUJI DARK VIOLET



01164 FUJI NEON PINK



01125 FUJI RED



01157 FUJI SALMON



## CYCLAMEN PERSICUM - MIDI FLOWER

## SUPER SERIE® REMBRANDT® F1



CODICE	VARIETÀ	COLOUR	COLORE	DISP. IN COLORI SEPARATI	Q. EXTRA	CRESCITA	PRECOCITÀ	FOGLIA	TIPO DI FIORE	UTILIZZO
01961	DARK VIOLET	violet foncé	viola scuro		●					10-12
01166	LIGHT VIOLET	violet clair	viola chiaro		●					10-12
01962	LIGHT WITH EYE IMPR.	blanc rose à oeil	bianco rosato c/o		●					10-12
01752	NEON FLAMED	rose neon flammé	rosa neon fiammato		●					10-12
01963	NEON PINK	rose neon	rosa neon		●					10-12
01168	ORCHID	lilas fuchsia	orchidea		●					10-12
01964	PURE WHITE	blanc pur	bianco puro		●					10-12
01965	SALMON RED	rouge saumoné	rosso salmone		●					10-12
01966	WINE RED	rouge lie de vin	rosso vino		●					10-12
01951	MIXED	mélange	mix	★ 3X91	●					10-12



01951 MIXED

## TIANIS® F1



CODICE	VARIETÀ	COLOUR	COLORE	DISP. IN COLORI SEPARATI	Q. EXTRA	CRESCITA	PRECOCITÀ	FOGLIA	TIPO DI FIORE	UTILIZZO
01533	BLANC évolution	white	bianco evol.	★ 3X91	●					10-12
01090	BLANC PUR	pure white	bianco puro							10-12
01095	FUCHSIA	fuchsia	fuchsia	★ 3X91	●					10-12
01126	FUCHSIA VIF	deep fuchsia	fuchsia intenso	★ 3X91	●					10-12
01872	MAGENTA	magenta	rosso porpora							10-12
01130	MAGENTA FONCÉ	deep magenta	magenta scuro	★ 3X91	●					10-12
01651	ROSE À OEIL LISERÉ	rose with eye picotee	rosa chiaro c/ bordo scuro							10-12
01933	ROUGE ÉCARLATE	scarlet red	rosso scarlatto	★ 3X91	●					10-12
01537	ROUGE VIF	bright red	rosso intenso							10-12
01613	SAUMON À OEIL	salmon with eye	salmone c/o							10-12
01481	SAUMON FONCÉ	deep salmon	salmone scuro	★ 3X91	●					10-12
01873	VIOLET FONCÉ	purple	viola scuro	★ 3X91	●					10-12
01091	MÉLANGE FLAMMÉ	flamed mix	fiammato mix	★ 3X91	●					10-12
01482	MÉLANGE SUCCESS®	success mix	success mix	★ 3X91	●					10-12



01533 BLANC évolution



01090 BLANC PUR



01095 FUCHSIA



01126 FUCHSIA VIF



01872 MAGENTA



01130 MAGENTA FONCÉ



01651 ROSE À OEIL LISERÉ



01933 ROUGE ÉCARLATE



01537 ROUGE VIF



01613 SAUMON À OEIL



01481 SAUMON FONCÉ



01873 VIOLET FONCÉ

## CYCLAMEN PERSICUM - MIDI FLOWER



01091 MÉLANGE FLAMMÉ



01482 MÉLANGE SUCCESS®

## TIANIS® F1 FANTASIA®



CODICE	VARIETÀ	COLOUR	COLORE	DISP. IN COLORI SEPARATI	Q. EXTRA	CRESCITA	PRECOCITÀ	FOGLIA	TIPO DI FIORE	UTILIZZO
01808	FANTASIA® FUCHSIA	FANTASIA fuchsia	fuchsia c/bordo bianco							10-12
01534	FANTASIA® FUCHSIA VIF	FANTASIA deep fuchsia	fuchsia intenso c/bordo bianco	★ 3X91	●					10-12
01614	FANTASIA® MAGENTA FONCÉ	FANTASIA deep magenta	rosso porpora c/ bordo bianco	★ 3X91	●					10-12
01649	FANTASIA® ROUGE ÉCARLATE	FANTASIA scarlet red	rosso c/bordo bianco	★ 3X91						10-12
01536	FANTASIA® VIOLET	FANTASIA light purple	viola c/bordo bianco							10-12
01615	FANTASIA® VIOLET FONCÉ	FANTASIA purple	viola scuro c/bordo bianco	★ 3X91	●					10-12
01665	FANTASIA® MÉLANGE	FANTASIA mix	mix fantasia	★ 3X91	●					10-12



01808 FANTASIA® FUCHSIA



01534 FANTASIA® FUCHSIA VIF



01614 FANTASIA® MAGENTA FONCÉ



01649 FANTASIA® ROUGE ÉCARLATE



01536 FANTASIA® VIOLET



01615 FANTASIA® VIOLET FONCÉ



01665 FANTASIA® MELANGE





SENTIER: GIOVANI PIANTE DI CICLAMINO IN 91 FORI - CYCLAMEN YOUNG PLANTS IN 91 TRAYS



## CYCLAMEN PERSICUM - MINI FLOWER

## METIS® F1



CODICE	VARIETÀ	COLOUR	COLORE	DISP. IN COLORI SEPARATI	Q. EXTRA	CRESCITA	PRECOCITÀ	FOGLIA	TIPO DI FIORE	UTILIZZO
01618	BLANC À OEIL	white with eye	bianco c/o	★ 3X91	●					06-10
01811	BLANC PUR EVOL.	pure white evolution	bianco puro	★ 3X91	●					06-10
01585	ÉCARLATE COMPACT	scarlet compact	scarlatto, compatto	★ 3X91						06-10
01143	FUCHSIA & FUCHSIA VIF	rose shades	fuchsia e fuchsia intenso	★ 3X91	●					06-10
01538	FUCHSIA VIF	bright rose	fuchsia intenso	★ 3X91	●					06-10
01981	FUCHSIA "AQUAREL"	fuchsia clair	fuchsia "chiaro"	★ 3X91						06-10
01780	LILAS CLAIR À OEIL	light lilac with eye	lilla chiaro c/o	★ 3X91						06-10
01230	MAGENTA FONCÉ	deep magenta	rosso porpora scuro	★ 3X91	●					06-10
01812	ROSE CLAIR À OEIL	light pink with eye	rosa chiaro c/o	★ 3X91	●					06-10
01467	ROSE DE PERSE	persian rose	rosa lilla	★ 3X91	●					06-10
01149	ROSE SAUMONÉ	salmon rose	rosa salmone	★ 3X91						06-10
01843	ROUGE VIF COMPACT	bright red compact	rosso intenso, compatto	★ 3X91	●					06-10
01539	SAUMON ÉCARLATE COMPACT	scarlet salmon compact	rosso salmone, compatto	★ 3X91	●					06-10
01302	VIOLET	purple	viola	★ 3X91	●					06-10
01403	VIOLET FONCÉ	deep purple	viola intenso	★ 3X91						06-10
01654	MÉLANGE FLAMMÉ	flamed mix	miscuglio fiammato	★ 3X91	●					06-10
01154	MÉLANGE	mixed	mix	★ 3X91						06-10



01618 BLANC À OEIL



01811 BLANC PUR EVOL.



01585 ÉCARLATE COMPACT



01143 FUCHSIA &amp; FUCHSIA VIF



01538 FUCHSIA VIF



01981 FUCHSIA "AQUAREL"

## MINI FLOWER - CYCLAMEN PERSICUM



01780 LILAS CLAIR À OEIL



01230 MAGENTA FONCÉ



01812 ROSE CLAIR À OEIL



01467 ROSE DE PERSE



01149 ROSE SAUMONÉ



01843 ROUGE VIF COMPACT



01539 SAUMON ÉCARLATE COMPACT



01302 VIOLET



01403 VIOLET FONCÉ



01654 MÉLANGE FLAMMÉ



## CYCLAMEN PERSICUM - MINI FLOWER

## METIS® F1 DECORA



CODICE	VARIETÀ	COLOUR	COLORE	DISP. IN COLORI SEPARATI	Q. EXTRA	CRESCITA	PRECOCITÀ	FOGLIA	TIPO DI FIORE	UTILIZZO
01374	BLANC PUR DÉCORA	pure white silver leaf	bianco puro fo. decora							06-10
01380	FUCHSIA CLAIR DÉCORA exp.	light rose silver leaf	fuchsia chiaro fo. decora							06-10
01935	FUCHSIA VIF DÉCORA	deep rose silver leaf	fuchsia intenso fo. decora							06-10
01466	MAGENTA DÉCORA	magenta silver leaf	rosso porpora fo. decora							06-10
01208	MAGENTA FONCÉ DÉCORA	deep magenta silver leaf	porpora scuro fo. decora							06-10
01616	ROSE DE PERSE DÉCORA	persian rose silver leaf	rosa lilla fo. decora							06-10
01936	ROUGE ÉCARLATE DÉCORA	scarlet red silver leaf	scarlatta fo. decora							06-10
01813	SAUMON DÉCORA	salmon silver leaf	salmone fo. decora							06-10
01937	SAUMON ÉCARLATE DÉCORA	scarlet salmon silver leaf	rosso salmone fo. decora							06-10
01617	VIOLET DÉCORA	purple silver leaf	viola fo. decora							06-10
01938	VIOLET FONCÉ DÉCORA exp.	deep purple silver leaf	viola scuro fo. decora							06-10
01844	MÉLANGE DÉCORA	silver leaf mix	mix fo. decora	★ 3X91						06-10



01844 MÉLANGE DÉCORA

## METIS® F1 FANTASIA®



CODICE	VARIETÀ	COLOUR	COLORE	DISP. IN COLORI SEPARATI	Q. EXTRA	CRESCITA	PRECOCITÀ	FOGLIA	TIPO DI FIORE	UTILIZZO
01939	FANTASIA® MAGENTA FONCÉ	FANTASIA deep magenta	magenta scuro c/bordo bianco	★ 3X91	●					06-10
01316	FANTASIA® ROUGE	FANTASIA red	rosso c/bordo bianco	★ 3X91	●					06-10
01940	FANTASIA® ROUGE & FUCHSIA VIF	FANTASIA red and deep rose	rosso e fuchsia c/ bordo bianco	★ 3X91	●					06-10
01941	FANTASIA® SAUMON ÉCARLATE	FANTASIA scarlet salmon	rosso salmone c/bordo bianco	★ 3X91	●					06-10
01942	FANTASIA® VIOLET FONCÉ	FANTASIA purple	viola scuro c/bordo bianco	★ 3X91	●					06-10
01943	FANTASIA® MÉLANGE	FANTASIA mixed	fantasia mix	★ 3X91	●					06-10



01939 FANTASIA® MAGENTA FONCÉ



01316 FANTASIA® ROUGE



01940 FANTASIA® ROUGE &amp; FUCHSIA VIF



01941 FANTASIA® SAUMON ÉCARLATE



01942 FANTASIA® VIOLET FONCÉ

## METIS® F1 VICTORIA MINI



CODICE	VARIETÀ	COLOUR	COLORE	DISP. IN COLORI SEPARATI	Q. EXTRA	CRESCITA	PRECOCITÀ	FOGLIA	TIPO DI FIORE	UTILIZZO
01274	VICTORIA DECO MIX EVOL.	victoria deco mix evolution	victoria mix fo.argent. migliorato	★ 3X91						06-10



01274 VICTORIA DECO MIX EVOL.

## CYCLAMEN PERSICUM - MINI FLOWER

## SMARTIZ® F1 MINI



CODICE	VARIETÀ	COLOUR	COLORE	DISP. IN COLORI SEPARATI	Q. EXTRA	CRESCITA	PRECOCITÀ	FOGLIA	TIPO DI FIORE	UTILIZZO	
01983	SMARTIZ® BLANC PUR	pure white	bianco puro			●					
01404	SMARTIZ® FUCHSIA	fuchsia	fuchsia			●					
01405	SMARTIZ® FUCHSIA VIF	deep fuchsia	fuchsia intenso			●					
01406	SMARTIZ® MAGENTA FONCÉ	deep magenta	magenta scuro			●					
01196	SMARTIZ® ROSE SAUMONÉ exp.	salmon rose	rosa salmone			●					
01984	SMARTIZ® ROUGE VIF	bright red	rosso vivo			●					
01413	SMARTIZ® SAUMON exp.	salmon	salmone			●					
01414	SMARTIZ® VIOLET	purple	viola			●					
01985	SMARTIZ® VIOLET FONCÉ	deep purple	viola scuro			●					
01161	SMARTIZ® MÉLANGE CLAIR exp.	mixed	mix classico chiaro			●					
01934	SMARTIZ® MÉLANGE	mixed	mix	★ 3X91		●					



01934 SMARTIZ® MÉLANGE

## SMARTIZ® F1 FANTASIA®



CODICE	VARIETÀ	COLOUR	COLORE	DISP. IN COLORI SEPARATI	Q. EXTRA	CRESCITA	PRECOCITÀ	FOGLIA	TIPO DI FIORE	UTILIZZO
01386	FANTASIA® FUCHSIA	FANTASIA fuchsia	fuchsia c/bordo bianco							06-10
01171	FANTASIA® MAGENTA	FANTASIA magenta	rosso porpora c/bordo bianco							06-10
01278	FANTASIA® ROUGE VIF	FANTASIA scarlet red	rosso vivo c/bordo bianco							06-10
01167	FANTASIA® VIOLET FONCÉ	FANTASIA purple	viola scuro c/bordo bianco							06-10
01124	FANTASIA® MÉLANGE	FANTASIA mixed	fantasia mix	★	3X91					06-10



01386 FANTASIA® FUCHSIA



01171 FANTASIA® MAGENTA



01278 FANTASIA® ROUGE VIF



01124 FANTASIA® MÉLANGE



01167 FANTASIA® VIOLET FONCÉ

## CYCLAMEN PERSICUM - MINI FLOWER

## SUPER SERIE® CARINO® F1



CODICE	VARIETÀ	COLOUR	COLORE	DISP. IN COLORI SEPARATI	Q. EXTRA	CRESCITA	PRECOCITÀ	FOGLIA	TIPO DI FIORE	UTILIZZO
01310	CREAM WHITE	blanc crème	bianco crema	★	●					06-10
01968	DARK SALMON PINK	rose saumon foncé	rosa salmone scuro	★	●					06-10
01969	DARK VIOLET	violet foncé	viola scuro	★	●					06-10
01970	DEEP DARK VIOLET	violet foncé vif	viola scuro intenso	★	●					06-10
01428	DEEP NEON FLAMED	rose neon flammé	rosa neon fiammato	★	●					06-10
01971	DEEP WINE RED	rouge lie de vin vif	rosso vino intenso	★	●					06-10
01972	LIGHT SALMON PINK	rose saumon clair	rosa salmone chiaro	★	●					06-10
01973	NEON PINK	rose neon	rosa neon	★	●					06-10
01318	PINK W/EYE	rose à oeil	rosa c/occhio	★	●					06-10
01974	PURE WHITE	blanc pur	bianco puro	★	●					06-10
01975	RED	rouge	rosso	★	●					06-10
01429	SALMON FLAMED	saumon flammé	salmone fiammato	★	●					06-10
01366	SALMON WITH EYE	saumon à oeil	salmone con occhio	★	●					06-10
01902	WINE RED	rouge lie de vin	rosso vino	★	●					06-10
01976	WINE RED FLAMED	rouge lie de vin flammé	rosso vino fiammato	★	●					06-10
01295	FLAMED MIXED	mélange flammé	fiammato mix	★	●					06-10
01952	MIXED	mélange	mix	★	●					06-10



01310 CREAM WHITE



01968 DARK SALMON PINK



01969 DARK VIOLET



01970 DEEP DARK VIOLET



01428 DEEP NEON FLAMED



01971 DEEP WINE RED

## MINI FLOWER - CYCLAMEN PERSICUM



01972 LIGHT SALMON PINK



01973 NEON PINK



01318 PINK W/EYE



01974 PURE WHITE



01975 RED



01429 SALMON FLAMED



01366 SALMON WITH EYE



01902 WINE RED



01976 WINE RED FLAMED



01295 FLAMED MIXED



01952 MIXED

## CYCLAMEN PERSICUM - MINI FLOWER

## SUPER SERIE® CARINO® F1 FUJI



CODICE	VARIETÀ	COLOUR	COLORE	DISP. IN COLORI SEPARATI	O. EXTRA	CRESCITA	PRECOCITÀ	FOGLIA	TIPO DI FIORE	UTILIZZO
01121	FUJI MAGENTA	magenta bicouleur	rosso porpora c/bordo bianco	★ 3X91	●					
01828	FUJI NEON PINK	rose neon bicouleur	rosa neon c/bordo bianco	★ 3X91	●					
01741	FUJI RED	rouge bicouleur	rosso c/bordo bianco	★ 3X91	●					
01836	FUJI WINE RED	rouge lie de vin bicouleur	rosso vino c/bordo bianco	★ 3X91	●					
01173	CARINO® FUJI MIX	mélange bicouleur	mix c/bordo bianco	★ 3X91	●					



01121 FUJI MAGENTA



01828 FUJI NEON PINK



01741 FUJI RED



01836 FUJI WINE RED



01173 CARINO® FUJI MIX



## SUPER SERIE® COMPACT F1



CODICE	VARIETÀ	COLOUR	COLORE	DISP. IN COLORI SEPARATI	Q. EXTRA	CRESCITA	PRECOCITÀ	FOGLIA	TIPO DI FIORE	UTILIZZO
01472	DARK VIOLET	violet foncé	viola scuro	★ 91TRAY	●					06-10
01542	LIGHT NEON PINK	rose clair neon	rosa chiaro neon	★ 91TRAY	●					06-10
01311	LIGHT VIOLET	violet clair	viola chiaro	★ 91TRAY	●					06-10
01313	NEON FLAMED	rose neon flammé	rosa neon fiammato		●					06-10
01219	NEON PINK	rose neon	rosa neon	★ 91TRAY	●					06-10
01660	PURE WHITE	blanc pur	bianco puro	★	●					06-10
01213	RED	rouge	rosso	★	●					06-10
01842	SALMON FLAMED	saumon flammé	salmone fiammato							06-10
01216	SALMON RED	rouge saumoné	rosso salmone	★ 91TRAY	●					06-10
01473	SALMON w. EYE	saumon à oeil	salmone c/o	★ 91TRAY						06-10
01162	VIOLET DIP	violet	viola		●					06-10
01662	VIOLET FLAMED	violet flammé	viola fiammato		●					06-10
01224	WHITE w. EYE	blanc à oeil	bianco c/o	★ 91TRAY						06-10
01214	WINE RED	rouge lie de vin	rosso vino	★ 91TRAY						06-10
01661	WINE RED FLAMED	rouge lie de vin flammé	rosso vino fiammato		●					06-10
01399	FUJI RED	rouge bicouleur	rosso c/bordo bianco	★ 91TRAY	●					06-10
01474	FLAMED MIX	mélange flammé	fiammato mix	★	●					06-10
01544	MIXED	mélange	mix	★						06-10



01472 DARK VIOLET



01542 LIGHT NEON PINK



01311 LIGHT VIOLET



01313 NEON FLAMED



01219 NEON PINK



01660 PURE WHITE

Disponibili solo in miscuglio fiammato - Available only in flamed mix  
Disponibles seulement en mélange flammé



## CYCLAMEN PERSICUM - MINI FLOWER

**01213 RED****01842 SALMON FLAMED**

Disponibile solo nel miscuglio fiammato - Available only in flamed mix  
Disponibles seulement en mélange flammé

**01216 SALMON RED****01473 SALMON w. EYE****01162 VIOLET DIP**

Disponibile solo nel miscuglio fiammato - Available only in flamed mix  
Disponibles seulement en mélange flammé

**01662 VIOLET FLAMED**

Disponibile solo nel miscuglio fiammato - Available only in flamed mix  
Disponibles seulement en mélange flammé

**01224 WHITE w. EYE****01214 WINE RED****01661 WINE RED FLAMED**

Disponibile solo nel miscuglio fiammato - Available only in flamed mix  
Disponibles seulement en mélange flammé

**01399 FUJI RED**

## SUPER SERIE® COMPACT F1 FUJI



CODICE	VARIETÀ	COLOUR	COLORE	DISP. IN COLORI SEPARATI	O. EXTRA	CRESCITA	PRECOCITÀ	FOGLIA	TIPO DI FIORE	UTILIZZO
01395	DARK VIOLET	violet foncé bicouleur	viola scuro c/bordo bianco							06-10
01396	LIGHT VIOLET	violet clair bicouleur	viola chiaro c/bordo bianco							06-10
01397	NEON PINK	rose neon bicouleur	rosa neon c/bordo bianco		●					06-10
01399	RED	rouge bicouleur	rosso c/bordo bianco	★	●					06-10
01400	WINE RED	rouge lie de vin bicouleur	rosso vino c/bordo bianco							06-10
01401	MIXED	mélange bicouleur	mix c/bordo bianco	★	3X91					06-10



01395 FUJI DARK VIOLET



01396 FUJI LIGHT VIOLET



01397 FUJI NEON PINK



01399 FUJI RED



01400 FUJI WINE RED

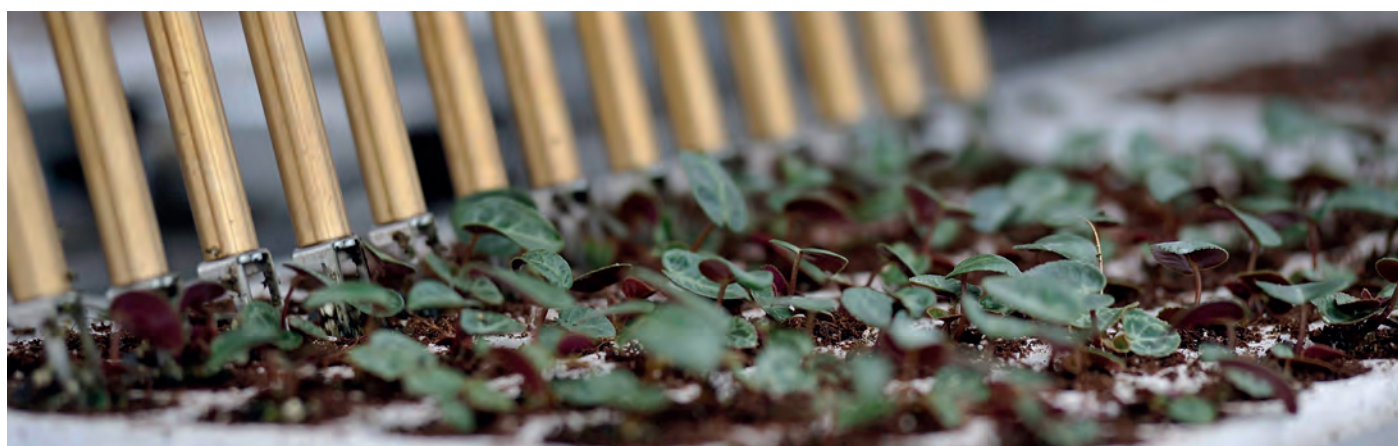

TRAPIANTO DI GIOVANI PIANTE DI CICLAMINO SENTIER - TRANSPLANT OF CYCLAMEN'S YOUNG PLANTS

## CYCLAMEN PERSICUM - MINI FLOWER

## SUPER SERIE® DONATELLO® F1



CODICE	VARIETÀ	COLOUR	COLORE	DISP. IN COLORI SEPARATI	Q. EXTRA	CRESCITA	PRECOCITÀ	FOGLIA	TIPO DI FIORE	UTILIZZO
00000	<b>NEW</b> CREAM WHITE	blanc crème	bianco crema							06-10
00000	<b>NEW</b> DARK VIOLET	violet foncé	viola scuro							06-10
00000	<b>NEW</b> DEEP WINE RED	rouge lie de vin vif	rosso vino intenso							06-10
00000	<b>NEW</b> NEON PINK	rose neon	rosa neon							06-10
00000	<b>NEW</b> RED	rouge	rosso							06-10
00000	<b>NEW</b> SALMON WITH EYE	saumon à oeil	salmone con occhio							06-10
00000	<b>NEW</b> WINE RED FLAMED	rouge lie de vin flammé	rosso vino fiammato							06-10
01263	<b>NEW</b> MIXED	mélange	mix		★ 3X91					06-10



00000 CREAM WHITE



00000 DARK VIOLET



00000 DEEP WINE RED



00000 NEON PINK



00000 RED



00000 SALMON WITH EYE



00000 WINE RED FLAMED



01263 MIXED

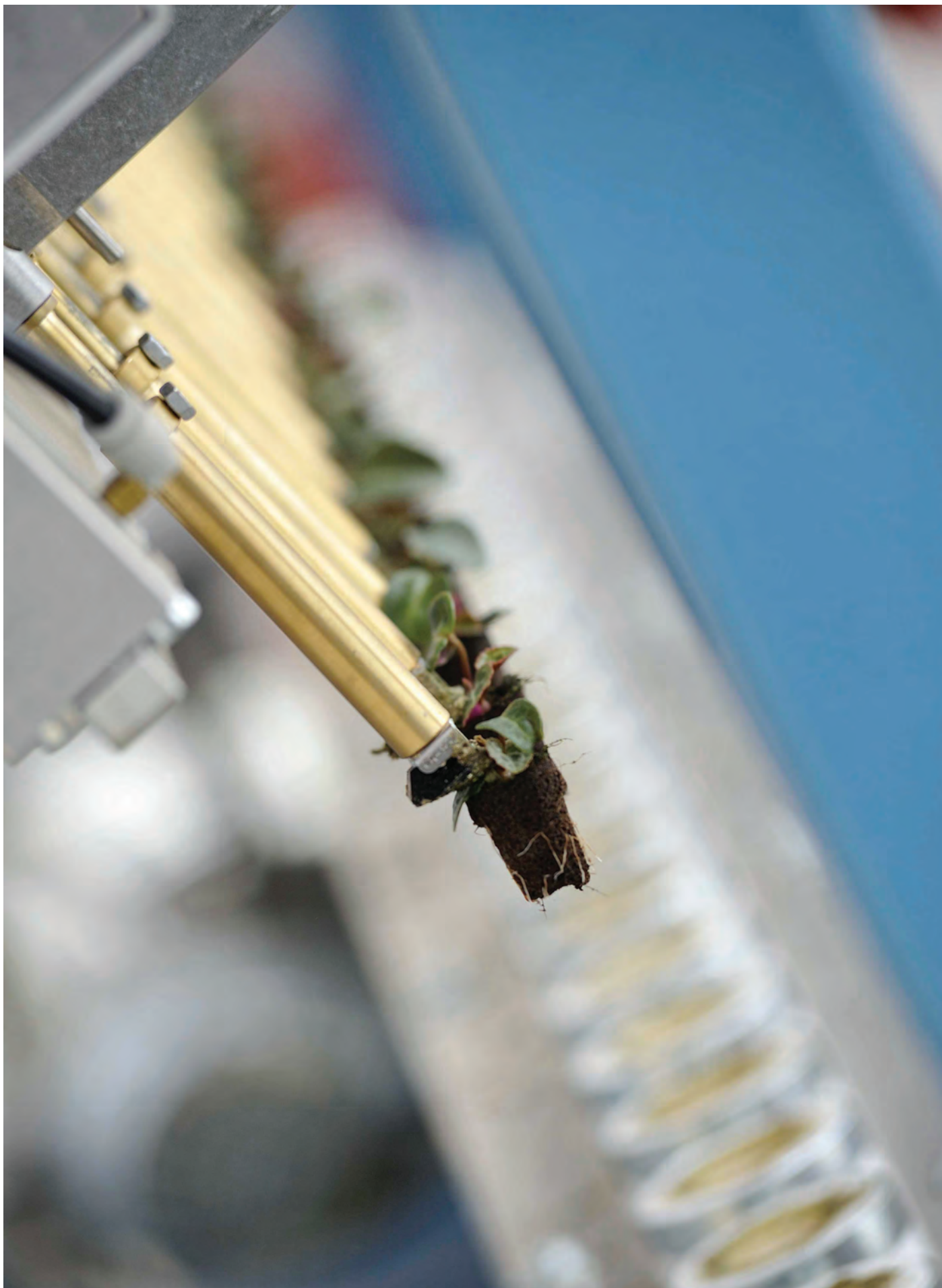

SENTIER: TRAPIANTO DI GIOVANI PIANTE DI CICLAMINO - TRANSPLANT OF CYCLAMEN'S YOUNG PLANTS

## CYCLAMEN PERSICUM - MINI FLOWER

## SUPER SERIE® PICASSO® F1



CODICE	VARIETÀ	COLOUR	COLORE	DISP. IN COLORI SEPARATI	O. EXTRA	CRESCITA	PRECOCITÀ	FOGLIA	TIPO DI FIORE	UTILIZZO
01781	CREAM WHITE	blanc crème	bianco crema							06-10
01713	DARK VIOLET	violet foncé	viola scuro							06-10
01790	LIGHT W. EYE	blanc rosé à oeil	bianco rosato c/o							06-10
01096	NEON PINK	rose neon	rosa neon							06-10
01683	RED	rouge	rosso							06-10
01564	SALMON WITH EYE	saumon à oeil	salmone con occhio							06-10
01725	VIOLET FLAMED	violet flammé	viola fiammato							06-10
01715	WINE RED	rouge lie de vin	rosso vino intenso							06-10
01724	WINE RED FLAMED	rouge lie de vin flammé	rosso vino fiammato							06-10
01627	MIXED	mélange	mix	★ 3X91						06-10



01781 CREAM WHITE



01713 DARK VIOLET



01790 LIGHT W. EYE



01096 NEON PINK



01683 RED



01564 SALMON WITH EYE



01725 VIOLET FLAMED



01715 WINE RED



01724 WINE RED FLAMED



01627 MIXED



SENTIER: CAMPO PROVA CICLAMINO - CYCLAMEN TRIAL

## CYCLAMEN PERSICUM - MINI FLOWER

## SUPER SERIE® VERANO® F1



CODICE	VARIETÀ	COLOUR	COLORE	DISP. IN COLORI SEPARATI	Q. EXTRA	CRESCITA	PRECOCITÀ	FOGLIA	TIPO DI FIORE	UTILIZZO
01619	CREAM WHITE	blanc crème	bianco crema	★	●					06-10
01326	DARK VIOLET	violet foncé	viola scuro	★	●					06-10
01719	DARK VIOLET SOLAR	violet foncé solar	viola scuro solar	★	●					06-10
01717	DEEP DARK VIOLET	violet vif foncé	viola scuro intenso		●					06-10
01469	DEEP NEON FLAMED SOLAR	rose neon foncé flammé	rosa neon fiammato solar	★	●					06-10
01977	DEEP SALMON FLAMED	saumon foncé flammé	salmone scuro fiammato	★	●					06-10
01845	DEEP WINE RED	rouge lie de vin vif	rosso vino intenso	★	●					06-10
01329	LIGHT VIOLET	violet clair	viola chiaro	★	●					06-10
01391	NEON FLAMED	rose neon flammé	rosa neon fiammato		●					06-10
01331	NEON PINK	rose neon	rosa neon	★	●					06-10
01120	PINK W/EYE	rose à oeil	rosa con occhio		●					06-10
01655	PURE WHITE SOLAR	blanc pur solar	bianco puro solar	★	●					06-10
01333	RED SOLAR	rouge solar	rosso solar	★	●					06-10
01718	SALMON FLAMED	saumon flammé	salmone fiammato	★	●					06-10
01369	SALMON WITH EYE	saumon à oeil	salmone con occhio	★	●					06-10
01920	VICTORIA SALMON	victoria saumon	vittoria salmone frangiato	★	●					06-10
01758	VIOLET FLAMED	violet flammé	viola fiammato	★	●					06-10
01335	WHITE WITH EYE	blanc à oeil	bianco c/o	★	●					06-10
01336	WINE RED	rouge lie de vin	rosso vino intenso	★	●					06-10
01656	WINE RED FLAMED	rouge lie de vin flammé	rosso vino fiammato	★	●					06-10
01815	FLAMED MIXED	mélange flammé	fiammato mix	★	●					06-10
01337	MIXED	mélange	mix	★	●					06-10



01619 CREAM WHITE



01326 DARK VIOLET



01719 DARK VIOLET SOLAR



01717 DEEP DARK VIOLET



01469 DEEP NEON FLAMED SOLAR



01977 DEEP SALMON FLAMED

Disponibile solo in miscuglio - Available only in mix  
Disponibles seulement en mélange

## MINI FLOWER - CYCLAMEN PERSICUM



01845 DEEP WINE RED



01329 LIGHT VIOLET



01391 NEON FLAMED

Disponibili solo in miscuglio - Available only in mix  
Disponibles seulement en mélange



01331 NEON PINK



01120 PINK W/EYE

Disponibili solo in miscuglio - Available only in mix  
Disponibles seulement en mélange



01655 PURE WHITE SOLAR



01333 RED SOLAR



01718 SALMON FLAMED



01369 SALMON WITH EYE



01920 VICTORIA SALMON



01758 VIOLET FLAMED



01335 WHITE WITH EYE



## CYCLAMEN PERSICUM - MINI FLOWER



01336 WINE RED



01656 WINE RED FLAMED



01337 MIXED



## SUPER SERIE® VERANO® F1 FUJI



CODICE	VARIETÀ	COLOUR	COLORE	DISP. IN COLORI SEPARATI	Q. EXTRA	CRESCITA	PRECOCITÀ	FOGLIA	TIPO DI FIORE	UTILIZZO
01122	FUJI DARK VIOLET	violet foncé bicouleur	viola scuro c/bordo bianco	★ ONLY 3X91	●					06-10
01260	FUJI NEON PINK IMPR.	rose neon bicouleur	rosa neon c/bordo bianco	★ ONLY 3X91	●					06-10
01520	FUJI SALMON	saumon bicouleur	salmone c/bordo bianco	★ ONLY 3X91	●					06-10
01272	FUJI WINE RED	rouge lie de vin bicouleur	rosso vino c/bordo bianco	★ ONLY 3X91	●					06-10
01270	VERANO® FUJI MIX	mélange bicouleur	mix c/bordo bianco	★ 3X91 1X264	●					06-10



01122 FUJI DARK VIOLET



01260 FUJI NEON PINK



01520 FUJI SALMON



01272 FUJI WINE RED



01270 VERANO® FUJI MIX



## CYCLAMEN PERSICUM - MINI FLOWER

## SUPER SERIE® MINI WINTER® F1



CODICE	VARIETÀ	COLOUR	COLORE	DISP. IN COLORI SEPARATI	Q. EXTRA	CRESCITA	PRECOCITÀ	FOGLIA	TIPO DI FIORE	UTILIZZO
01378	CREAM WHITE	blanc crème	bianco crema							06-10
01444	DARK VIOLET	violet foncé	viola scuro							06-10
01711	DEEP DARK VIOLET	violet vif foncé	viola scuro intenso							06-10
01946	DEEP NEON PINK IMPR.	neon rose foncé	rosa neon intenso							06-10
01885	LIGHT NEON PINK	neon rose clair	rosa chiaro neon							06-10
01416	LIGHT SALMON PINK	rose saumon clair	rosa salmone chiaro							06-10
01443	LIGHT VIOLET	violet clair	viola chiaro							06-10
01432	NEON FLAMED	rose neon flammé	rosa neon fiammato							06-10
01431	NEON PINK	rose neon	rosa neon							06-10
01657	PURE WHITE	blanc pur	bianco puro							06-10
01226	RED	rouge	rosso							06-10
01387	SALMON WITH EYE	saumon à oeil	salmone c/o							06-10
01658	SALMON FLAMED	saumon flammé	salmone fiammato							06-10
01379	VIOLET FLAMED	violet flammé	viola fiammato							06-10
01430	WHITE w. EYE	blanc à oeil	bianco c/o							06-10
01441	WINE RED	rouge lie de vin	rosso vino							06-10
01470	WINE RED FLAMED	rouge lie de vin flammé	rosso vino fiammato							06-10
01471	FLAMED MIX	mélange flammé	fiammato mix	★ 3X91 1X264	●					06-10
01749	MIXED	mélange	mix	★ 3X91 1X264						06-10



01378 CREAM WHITE



01444 DARK VIOLET



01711 DEEP DARK VIOLET



01946 DEEP NEON PINK IMPR.



01885 LIGHT NEON PINK



01416 LIGHT SALMON PINK

## MINI FLOWER - CYCLAMEN PERSICUM



01443 LIGHT VIOLET



01432 NEON FLAMED



01431 NEON PINK



01657 PURE WHITE



01226 RED



01387 SALMON WITH EYE



01658 SALMON FLAMED



01379 VIOLET FLAMED



01430 WHITE w. EYE



01441 WINE RED



01470 WINE RED FLAMED



01749 MIXED

## CYCLAMEN PERSICUM - MINI FLOWER

## SUPER SERIE® MINI WINTER® F1 FUJI



CODICE	VARIETÀ	COLOUR	COLORE	DISP. IN COLORI SEPARATI	Q. EXTRA	CRESCITA	PRECOCITÀ	FOGLIA	TIPO DI FIORE	UTILIZZO
01183	FUJI MAGENTA & WINE RED MIX	magenta bic. & rouge lie de vin bicolore	magenta bic. e rosso vino c/bordo bianco	★ 3X91 1X264	●					06-10



01183 FUJI MAGENTA &amp; WINE RED MIX



GIOVANI PIANTE COLTIVATE IN 91 FORI - YOUNG PLANTS GROWN IN 91 TRAYS

## SUPER SERIE® JIVE® F1 (FRINGED) FRANGIATI



CODICE	VARIETÀ	COLOUR	COLORE	DISP. IN COLORI SEPARATI	Q. EXTRA	CRESCITA	PRECOCITÀ	FOGLIA	TIPO DI FIORE	UTILIZZO
01782	CREAM WHITE	blanc crème	bianco crema							06-10
01783	DARK VIOLET	violet foncé	viola scuro							06-10
01786	LIGHT SALMON PINK	rose saumon clair	rosa salmone chiaro							06-10
01900	NEON FLAMED	rose neon flammé	rosa neon fiammato							06-10
01787	NEON PINK	rose neon	rosa neon							06-10
01784	SALMON RED	rouge saumoné	rosso salmone							06-10
01948	SALMON FLAMED	saumon flammé	salmone fiammato							06-10
01901	VIOLET FLAMED	violet flammé	viola fiammato							06-10
01788	WHITE w. EYE	blanc à oeil	bianco c/o							06-10
01789	WINE RED	rouge lie de vin	rosso vino							06-10
01689	MIXED	mélange	frangiato mix	★ 3X91						06-10



01782 CREAM WHITE



01783 DARK VIOLET

## MINI FLOWER - CYCLAMEN PERSICUM



**01786** LIGHT SALMON PINK



**01900** NEON FLAMED



**01787** NEON PINK



**01784** SALMON RED



**01948** SALMON FLAMED



**01901** VIOLET FLAMED



**01788** WHITE w. EYE



**01789** WINE RED

## LEGENDA

### Crescita • Growth • Croissance

---



compatta  
compact  
compacte



medio-compatta  
medium-compact  
moyen compacte



vigorosa  
vigorous  
vigoureuse

**Precocità (vedi colonna settimana di fioritura)**  
**Precocity (look at the schedule of week of flowering)**  
**Précocité (voir tableau semaine de floraison)**

### Cimature • Pinching • Pincement

---



cimare 1 volta  
to pinch 1 time  
1 pincement



cimare 2 volte  
to pinch 2 times  
2 pincements



cimare più volte  
pinching more times  
· plus pincements



---

ASTER NOVI-BELGII

CELOSIA ARGENTEA

BY



RoyalVanZanten





## SHOWMAKERS® SERIES

NEW



CODICE	VARIETÀ	COLOUR	COLORE	TIPO DI FIORE	CRESCITA	TEMPI DI REAZ. SETT.	CIMATURE Ø CM 10	CIMATURE Ø CM 12	CIMATURE Ø CM 14
38001	NEW BABY PINK	clear pink	rosa chiaro	pom pom					
38002	NEW BLUE BAYOU	dark blue	blue scuro	pom pom		6.0			
38003	NEW FRESH PINK	pink	rosa	pom pom		5.5			
38004	NEW MAGENTA	magenta	magenta	pom pom		6.0			
38005	NEW SNOW WHITE	white	bianco	pom pom		5.5			



38001 BABY PINK



38002 BLUE BAYOU



38003 FRESH PINK



38004 MAGENTA



38005 SNOW WHITE

## TIARA® SERIES

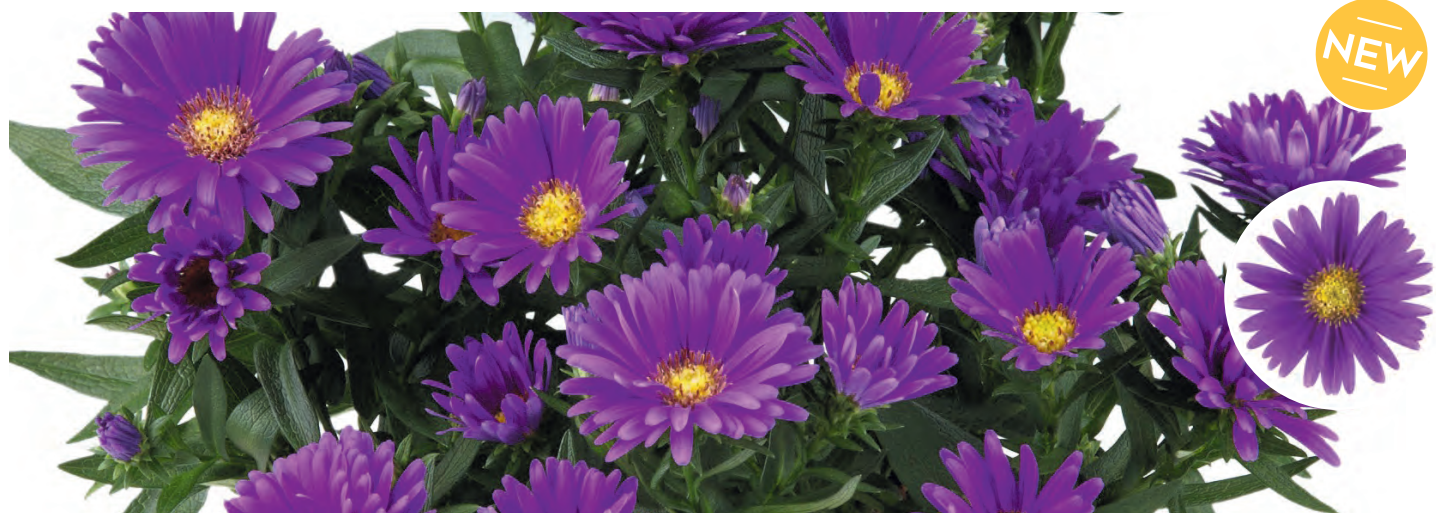

CODICE	VARIETÀ	COLOUR	COLORE	TIPO DI FIORE	CRESCITA	TEMPI DI REAZ. SETT.	CIMATURE Ø CM 10	CIMATURE Ø CM 12	CIMATURE Ø CM 14
<b>38006</b>	<b>NEW</b> BLUE PARROT	blue purple	blu viola	singolo		5.5			
<b>38007</b>	<b>NEW</b> HOT PINK	rose	rosa	singolo		5.5			
<b>38009</b>	<b>NEW</b> OPALE WHITE	white	bianco	singolo		5.0			
<b>38010</b>	<b>NEW</b> ROYAL PINK	pink	rosa	singolo		5.5			
<b>38011</b>	<b>NEW</b> ROYAL PURPLE	purple	viola	singolo		5.5			

**38006** BLUE PARROT**38007** HOT PINK**38009** OPALE WHITE**38010** ROYAL PINK**38011** ROYAL PURPLE



ASTER NOVI-BELGII SHOWMAKERS® IN MIXTURE OF COLOURS





## FLIRT® SERIES



CODICE	VARIETÀ	COLOUR	COLORE	TIPO DI FIORE	CRESCITA	TEMPI DI REAZIONE SETTIMANE
38012	LIME	lime	giallo limone	plumosa		6
38013	MAGENTA	magenta	magenta	plumosa		6
38014	RED	red	rosso	plumosa		6



38012 LIME



38013 MAGENTA



38014 RED

## HOT TOPIC® SERIES

NEW



CODICE	VARIETÀ	COLOUR	COLORE	TIPO DI FIORE	CRESCITA	TEMPI DI REAZIONE SETTIMANE
38016	NEW PINK	pink	rosa	cristata		6
38018	NEW RED	red	rosso	cristata		6
38019	NEW YELLOW	yellow	giallo	cristata		6



38016 PINK



38018 RED



38019 YELLOW

## MERIDA®

NEW



CODICE	VARIETÀ	COLOUR	COLORE	TIPO DI FIORE	CRESCITA	TEMPI DI REAZIONE SETTIMANE
38020	NEW PURPLE	purple	viola	spicata		5.5



38020 PURPLE







## LEGENDA

### Crescita • Growth • Croissance

---



compatta  
compact  
compacte



medio-compatta  
medium-compact  
moyen compacte



vigorosa  
vigorous  
vigoureuse

**Precocità (vedi colonna settimana di fioritura)**  
**Precocity (look at the schedule of week of flowering)**  
**Précocité (voir tableau semaine de floraison)**

### Cimature • Pinching • Pincement

---



cimare 1 volta  
to pinch 1 time  
1 pincement



cimare 2 volte  
to pinch 2 times  
2 pincements



cimare più volte  
pinching more times  
· plus pincements

### Regolatore di crescita • Growth's regulator • Régulateur de croissance

---



consigliato l'uso di regolatore di crescita  
it's recommended the use of growth's regulators  
il est conseillé l'emploi d'un régulateur de croissance



---

# CHRYSANTHEMUM



## CHRYSANTHEMUM - CRISANTEMO

### SETTEMBRINI GROUP - FLOWERING WEEK 38



CODICE	VARIETÀ	COLOUR	COLORE	TIPO DI FIORE	CRESCITA	SETTIMANA DI FIORITURA	RESISTENZA DEL FIORE
<b>19242</b>	WIKITA WHITE	white	bianco	Ziggy's spider*		38	
<b>19251</b>	VENOTTI	yellow	giallo	Dalia grande		38	
<b>19268</b>	POBO RED	red	rosso	Dalia grande		38	
<b>19280</b>	POBO PURPLE	violet/mauve	viola/malva	Dalia grande		38	
<b>19363</b>	FONTI DARK PINK	pink	rosa	Dalia		38	



**19242** WIKITA WHITE



**19251** VENOTTI



**19268** POBO RED



**19280** POBO PURPLE



**19363** FONTI DARK PINK



## PADRE GROUP - FLOWERING WEEK 39



CODICE	VARIETÀ	COLOUR	COLORE	TIPO DI FIORE	CRESCITA	SETTIMANA DI FIORITURA	RESISTENZA DEL FIORE
19244	PADRE WHITE	white	bianco	Dalia		39	
19296	PADRE YELLOW	yellow	giallo	Dalia		39	
19260	PADRE ORANGE	orange	arancio	Dalia		39	
19269	PADRE RED	red	rosso	Dalia		39	
19281	PADRE LILAC	violet/mauve	viola/malva	Dalia		39	



19244 PADRE WHITE



19296 PADRE YELLOW



19260 PADRE ORANGE



19269 PADRE RED



19281 PADRE LILAC

GIOVANI PIANTE DI CRISANTEMO  
YOUNG PLANTS OF CHRYSANTHEMUM

## CHRYSANTHEMUM - CRISANTEMO

### AMIKO GROUP - FLOWERING WEEK 41



CODICE	VARIETÀ	COLOUR	COLORE	TIPO DI FIORE	CRESCITA	SETTIMANA DI FIORITURA	RESISTENZA DEL FIORE
<b>19245</b>	AMIKO WHITE	white	bianco	Ziggy's grande		41	fiore resistente
<b>19253</b>	AMIKO YELLOW	yellow	giallo	Ziggy's grande		41	fiore resistente
<b>19261</b>	AMIKO ORANGE	orange	arancio	Ziggy's grande		41	fiore resistente
<b>19271</b>	AMIKO RED	red	rosso	Ziggy's grande		41	fiore resistente
<b>19276</b>	AMIKO PINK	pink/mauve	rosa	Ziggy's grande		41	fiore resistente
<b>19282</b>	AMIKO VIOLET	violet/mauve	malva	Ziggy's grande		41	fiore resistente



**19245** AMIKO WHITE



**19253** AMIKO YELLOW



**19261** AMIKO ORANGE



**19271** AMIKO RED



**19276** AMIKO PINK



**19282** AMIKO VIOLET

## ALUGA-VERITAS GROUP - FLOWERING WEEK 41



CODICE	VARIETÀ	COLOUR	COLORE	TIPO DI FIORE	CRESCITA	SETTIMANA DI FIORITURA	RESISTENZA DEL FIORE
<b>12246</b>	ALUGA WHITE	white	bianco	Dalia grande		41	fiore resistente
<b>19254</b>	ALUGA YELLOW	lemon yellow	giallo limone	Dalia grande		41	fiore resistente
<b>19314</b>	VERITAS YELLOW	yellow	giallo	Dalia		41	
<b>19263</b>	VERITAS ORANGE	orange	arancio	Dalia		41	
<b>19271</b>	AMIKO RED	red	rosso	Ziggy's grande		41	fiore resistente
<b>19283</b>	DAVOLA VIOLET	violet/mauve	malva	Dalia		41	fiore resistente

**19246** ALUGA WHITE**19254** ALUGA YELLOW**19314** VERITAS YELLOW**19263** VERITAS ORANGE**19271** AMIKO RED**19283** DAVOLA VIOLET

## CHRYSANTHEMUM - CRISANTEMO

### TOCCA GROUP - FLOWERING WEEK 42



CODICE	VARIETÀ	COLOUR	COLORE	TIPO DI FIORE	CRESCITA	SETTIMANA DI FIORITURA	RESISTENZA DEL FIORE
19247	ARTEMIS WHITE	white	bianco	Dalia		42	
19255	TOCCA YELLOW	yellow	giallo	Ziggy's grande		42	
19264	TOCCA ORANGE	orange bicolor	arancio bic	Ziggy's grande		42	
19295	UZARI RED	red	rosso	Dalia grande		42	
19284	ADURO VIOLET	violet/mauve bic	malva bic	Dalia grande		42	fiore resistente
19361	MONA PINK	mauve	malva	Dalia		42	



19247 ARTEMIS WHITE



19255 TOCCA YELLOW



19264 TOCCA ORANGE



19295 UZARI RED



19284 ADURO VIOLET



19361 MONA PINK

## STAVISKI GROUP - FLOWERING WEEK 42



CODICE	VARIETÀ	COLOUR	COLORE	TIPO DI FIORE	CRESCITA	SETTIMANA DI FIORITURA	RESISTENZA DEL FIORE
19301	STAVISKI WHITE	white	bianco	Dalia		42	
19302	STAVISKI YELLOW	yellow	giallo	Dalia		42	
19298	STAVISKI ORANGE	orange	arancio	Dalia		42	
19300	STAVISKI RED	red	rosso	Dalia		42	
19297	STAVISKI DARK PINK	mauve	malva	Dalia		42	
19299	STAVISKI PINK	pink	rosa	Dalia		42	



19301 STAVISKI WHITE

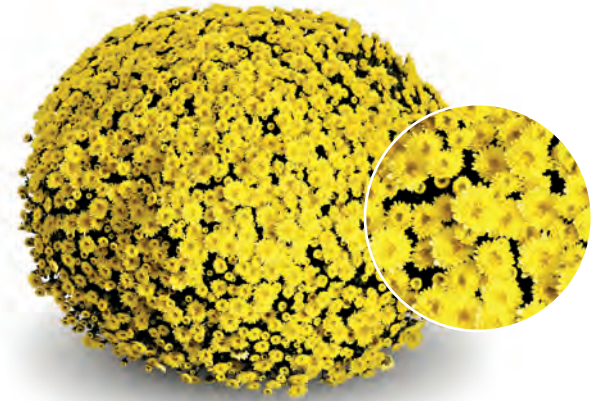

19302 STAVISKI YELLOW

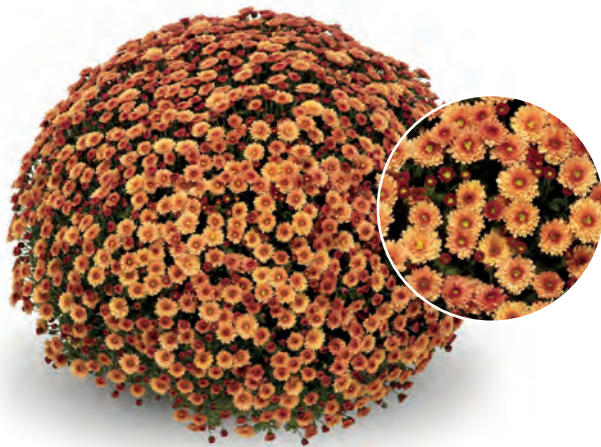

19298 STAVISKI ORANGE



19300 STAVISKI RED



19297 STAVISKI DARK PINK



19299 STAVISKI PINK



## CHRYSANTHEMUM - CRISANTEMO

### OTHER VARIETIES - FLOWERING WEEK 42



CODICE	VARIETÀ	COLOUR	COLORE	TIPO DI FIORE	CRESCITA	SETTIMANA DI FIORITURA	RESISTENZA DEL FIORE
<b>19316</b>	IBERA WHITE	white	bianco	Dalia		42-43	
<b>19317</b>	IBERA YELLOW	yellow	giallo	Dalia		42-43	
<b>19362</b>	SENGA	mauve	malva	Ziggy's grande		42	
<b>19361</b>	MONA PINK	mauve	malva	Dalia		42	



**19316** IBERA WHITE



**19317** IBERA YELLOW



**19362** SENGA



**19361** MONA PINK



SENTIER CAMPO PROVA CRISANTEMO - CHRYSANTHEMUM TRIAL

## MEFISTO GROUP - FLOWERING WEEK 43

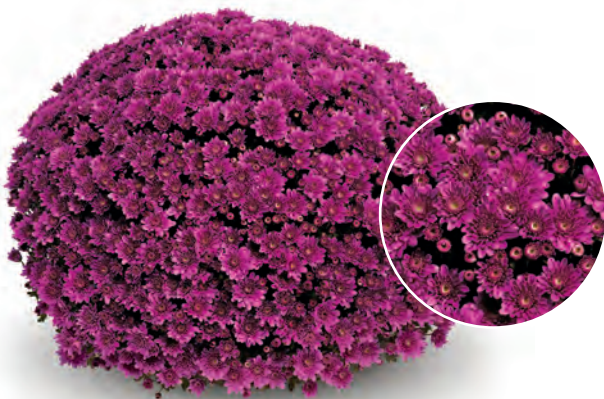

CODICE	VARIETÀ	COLOUR	COLORE	TIPO DI FIORE	CRESCITA	SETTIMANA DI FIORITURA	RESISTENZA DEL FIORE
<b>19249</b>	MATARI WHITE	white	bianco	Dalia		43	
<b>19348</b>	MEFISTO YELLOW	yellow	giallo	Dalia		43	
<b>19364</b> <small>NEW</small>	MEFISTO ORANGE	orange	arancio	Dalia		43	
<b>19272</b>	MEFISTO RED	red	rosso	Dalia		43	
<b>19285</b>	MEFISTO PURPLE	violet/mauve	malva	Dalia		43	

**19249** MATARI WHITE**19348** MEFISTO YELLOW**19364** MEFISTO ORANGE**19272** MEFISTO RED**19285** MEFISTO PURPLE

## CHRYSANTHEMUM - CRISANTEMO

### GUARINI GROUP - FLOWERING WEEK 43



CODICE	VARIETÀ	COLOUR	COLORE	TIPO DI FIORE	CRESCITA	SETTIMANA DI FIORITURA	RESISTENZA DEL FIORE
19249	MATARI WHITE	white	bianco	Dalia		43	
19349	GUARINI YELLOW	yellow	giallo	Dalia		43	
19265	GUARINI ORANGE	orange bicolor	arancio bic	Dalia		43	
19273	CONTIKI RED	red	rosso	Dalia grande		43	



19249 MATARI WHITE



19349 GUARINI YELLOW



19265 GUARINI ORANGE



19273 CONTIKI RED



SENTIER: CAMPO PROVA CRISANTEMO - CHRYSANTHEMUM TRIAL

## VIGORELLI GROUP - FLOWERING WEEK 43



CODICE	VARIETÀ	COLOUR	COLORE	TIPO DI FIORE	CRESCITA	SETTIMANA DI FIORITURA	RESISTENZA DEL FIORE
<b>19365</b>	NAZIMI WHITE	white	bianco	Dalia		43	
<b>19349</b>	GUARINI YELLOW	yellow	giallo	Dalia		43	
<b>19267</b>	VIGORELLI ORANGE	orange	arancio	Dalia		43	
<b>19350</b>	VIGORELLI RED	red	rosso	Dalia		43	
<b>19351</b>	VIGORELLI PURPLE	violet/mauve	malva	Dalia		43	
<b>19286</b>	VIGORELLI VIOLET	violet/mauve	malva	Dalia		43	



19365 NAZIMI WHITE



19349 GUARINI YELLOW

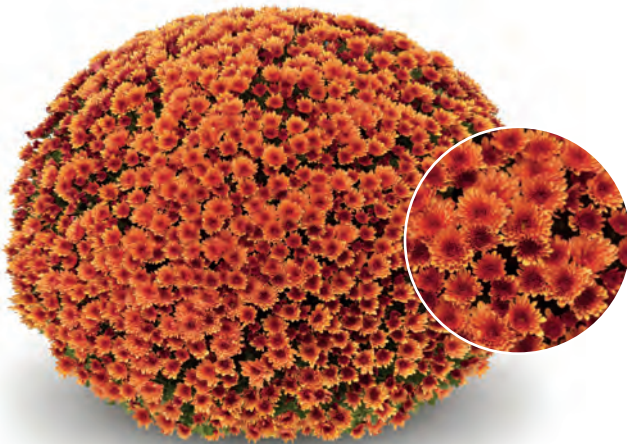

19267 VIGORELLI ORANGE



19350 VIGORELLI RED



19351 VIGORELLI PURPLE



19286 VIGORELLI VIOLET

## CHRYSANTHEMUM - CRISANTEMO

### MURANO GROUP AND OTHER VARIETIES - FLOWERING WEEK 43



CODICE	VARIETÀ	COLOUR	COLORE	TIPO DI FIORE	CRESCITA	SETTIMANA DI FIORITURA	RESISTENZA DEL FIORE
19250	MURANO WHITE	white	bianco	Ziggy's grande		43	
19258	MURANO YELLOW	lemon yellow	giallo limone	Ziggy's grande		43	
19257	MOURIA YELLOW	golden yellow	giallo oro	Dalia		43	
19319	PRIMO PISTACHE	green	verde	Ziggy's /pom pom		43	
19352	PRIMO SUNNY	yellow green	giallo verde	Ziggy's /pom pom		43	



19250 MURANO WHITE



19258 MURANO YELLOW



19257 MOURIA YELLOW



19319 PRIMO PISTACHE

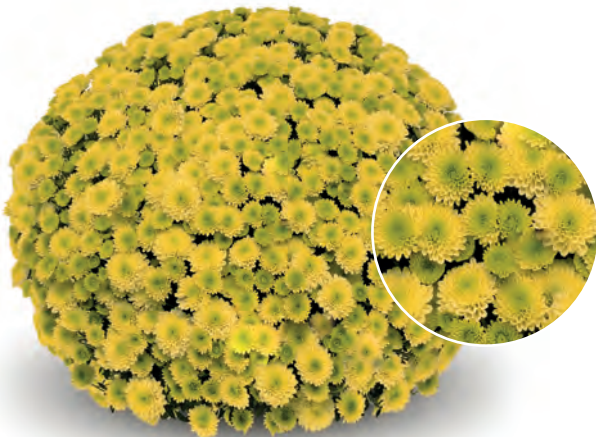

19352 PRIMO SUNNY





SENTIER: CAMPO PROVA CRISANTEMO - CHRYSANTHEMUM TRIAL

# CHRYSANTHEMUM - CRISANTEMO

## TRIOCRYSO



CODICE	VARIETÀ	COLOUR	COLORE	TIPO DI FIORE	CRESCITA	SETTIMANA DI FIORITURA	RESISTENZA DEL FIORE
19287	AMIKO MIX 2	Amiko white	bianco	Ziggy's grande		41	
		Amiko yellow	giallo				
		Amiko violet	viola				
19288	STAVISKI MIX 1	Staviski white	bianco	Dalia		42	
		Staviski yellow	giallo				
		Staviski dark pink	malva				
19289	STAVISKI MIX 2	Staviski pink	rosa	Dalia		42	
		Staviski red	rosso				
		Staviski yellow	giallo				
19290	MEFISTO 1	Ibera white	bianco	Dalia		43	
		Mefisto yellow	giallo				
		Mefisto red	rosso				
19291	MEFISTO 2	Ibera white	bianco	Dalia		43	
		Mefisto yellow	giallo				
		Mefisto purple	malva				
19353	GUARINI 1	Guarini yellow	giallo	Dalia		43	
		Guarini orange	arancio bic				
		Contiki red	rosso				
19354	VIGORELLI 1	Matari white	bianco	Dalia		43	
		Vigorelli orange	arancio				
		Vigorelli violet	malva				
19292	TOCCA MIX	Tocca yellow	giallo	Dalia grande		43	
		Tocca orange	arancio				
		Mefisto pink	rosa				
19318	TRICOLORE	Pianello white	bianco	Dalia		43	
		Pistache	verde				
		Pomax Red	rosso				



19287 AMIKO MIX 2



19288 STAVISKI MIX 1



19289 STAVISKI MIX 2

**19290** MEFISTO 1**19291** MEFISTO 2**19353** GUARINI 1**19354** VIGORELLI 1**19292** TOCCA MIX**19318** TRICOLORE





CRISANTEMO COLTIVAZIONE IN PIENO CAMPO - CHRYSANTHEMUM CULTIVATED OUTDOOR



# CHRYSANTHEMUM - CRISANTEMO

## BIG FLOWER



CODICE	VARIETÀ	COLOUR	COLORE	TIPO DI FIORE	CRESCITA	SETTIMANA FIORITURA	CIMATURE	REGOLATORE CRESCITA
19223	ALBA BLANC	pure white	bianco puro	a palla		43		
19229	GENIUS	pure white	bianco puro	a palla		43		
19215	LOVELYS® (SUD)	pure white	bianco puro	a palla		43		
19218	TOLERANCE® (SUD)	white	bianco	a palla		43		
19100	VIRGINIA	pure white	bianco puro	a palla		42		
19355	CIEL D'OR	yellow	giallo	a palla		43		
19356	DOUCEUR	yellow	giallo	a palla		43		
19101	MAURA	yellow	giallo	a palla		42		
19007	PASSIONNEMENT® JAUNE	yellow	giallo	a palla		43		
19008	SWANN®	bright yellow	giallo brillante	a palla		43		
19220	TOLERANCE® JAUNE	yellow	giallo	a palla		43		
19357	DARINA	kopper	rame	a palla		43		
19358	DIEGO ROUGE	red	rosso	a palla		43		
19010	PASSION® ROUGE ET OR	red and gold	rosso e oro	a palla		43		
19020	SUCCÈS® ROUGE ET OR	bright red and gold	rosso brillante e oro	a palla		43		
19359	FAIBELLE	violet mauve	viola malva	a palla		43		
19013	SATINBLEU®	bright rose	rosa brillante	a palla		43		
19017	SUCCÈS® VIOLET	violet mauve	viola malva	a palla		43		



19229 GENIUS



19215 LOVELYS®



19223 ALBA BLANC



19218 TOLERANCE®



19100 VIRGINIA

**19355 CIEL D'OR****19356 DOUCEUR****19101 MAURA****19007 PASSIONNEMENT® JAUNE****19008 SWANN®****19357 DARINA**

## CHRYSANTHEMUM - CRISANTEMO



19358 DIEGO ROUGE



19010 PASSION® ROUGE ET OR



19020 SUCCÈS® ROUGE ET OR



19359 FAIBELLE



19013 SATINBLEU®



19017 SUCCÈS® VIOLET

## SAMOURAI SERIES



CODICE	VARIETÀ	COLOUR	COLORE	TIPO DI FIORE	CRESCITA	SETTIMANA DI FIORITURA	CIMATURE	REGOLATORE CRESCITA
19005	JACANA®	bright yellow	giallo brillante	a palla		43		



19005 JACANA®



## CHRYSANTHEMUM - CRISANTEMO

### SPECIAL FLOWER



CODICE	VARIETÀ	COLOUR	COLORE	TIPO DI FIORE	CRESCITA	SETTIMANA DI FLORITURA	CIMATURE	REGOLATORE CRESCITA
19030	PANTIN®	rose	rosa	Multifl. grande		42		
19022	PANTIN® BLANC	white	bianco	Multifl. grande		42		
19079	PANTIN® JAUNE	yellow	giallo	Multifl. grande		42		
19210	PANTIN® ORANGE	orange	arancio	Multifl. grande		42		



19030 PANTIN®



19022 PANTIN® BLANC



19079 PANTIN® JAUNE



19210 PANTIN® ORANGE

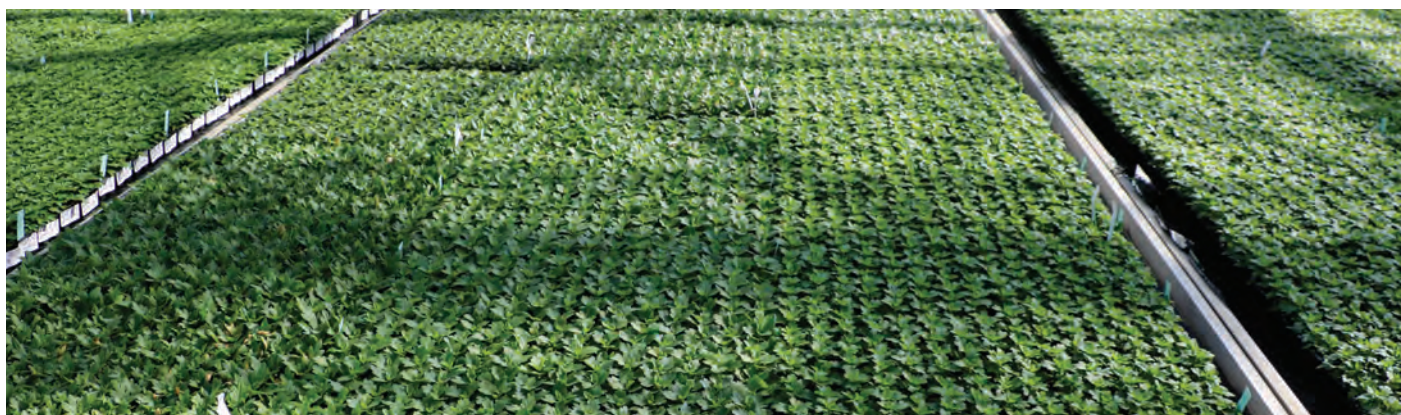

SENTIER: SERRE DI COLTIVAZIONE CRISANTEMI - SENTIER'S GREENHOUSES: CULTIVATION OF CHRYSANTHEMUM YOUNG PLANTS

## TABELLA PER LA COLTIVAZIONE DEL CRISANTEMO TRADIZIONALE FIORE A PALLA SCHEDULE FOR THE GROWING OF TRADITIONAL CHRYSANTHEMUM WITH BALL FLOWER

settimana	Maggio					Giugno					Luglio					Agosto					Settembre					Ottobre					Novembre				
	18	19	20	21	22	23	24	25	26	27	28	29	30	31	32	33	34	35	36	37	38	39	40	41	42	43	44	45	46						
Coltivazione tradizionale			🪴✂️	🪴✂️	🪴✂️	🪴✂️	🪴✂️	🪴✂️	🪴✂️	🪴✂️	🪴✂️	🪴✂️	🪴✂️	🪴✂️	🪴✂️	🪴✂️	🪴✂️	🪴✂️	🪴✂️	🪴✂️	🪴✂️	🪴✂️	🪴✂️	🪴✂️	🪴✂️	🪴✂️	🪴✂️	🪴✂️	🪴✂️						
Coltivazione tradizionale						🪴✂️	🪴✂️	🪴✂️	🪴✂️	🪴✂️	🪴✂️	🪴✂️	🪴✂️	🪴✂️	🪴✂️	🪴✂️	🪴✂️	🪴✂️	🪴✂️	🪴✂️	🪴✂️	🪴✂️	🪴✂️	🪴✂️	🪴✂️	🪴✂️	🪴✂️	🪴✂️	🪴✂️						
Coltivazione tradizionale								🪴✂️	🪴✂️	🪴✂️	🪴✂️	🪴✂️	🪴✂️	🪴✂️	🪴✂️	🪴✂️	🪴✂️	🪴✂️	🪴✂️	🪴✂️	🪴✂️	🪴✂️	🪴✂️	🪴✂️	🪴✂️	🪴✂️	🪴✂️	🪴✂️	🪴✂️						
Coltivazione con 1 spuntatura						🪴✂️	🪴✂️	🪴✂️	🪴✂️	🪴✂️	🪴✂️	🪴✂️	🪴✂️	🪴✂️	🪴✂️	🪴✂️	🪴✂️	🪴✂️	🪴✂️	🪴✂️	🪴✂️	🪴✂️	🪴✂️	🪴✂️	🪴✂️	🪴✂️	🪴✂️	🪴✂️	🪴✂️						
Coltivazione con 1 spuntatura								🪴✂️	🪴✂️	🪴✂️	🪴✂️	🪴✂️	🪴✂️	🪴✂️	🪴✂️	🪴✂️	🪴✂️	🪴✂️	🪴✂️	🪴✂️	🪴✂️	🪴✂️	🪴✂️	🪴✂️	🪴✂️	🪴✂️	🪴✂️	🪴✂️	🪴✂️						
Coltivazione di 2 talee con 1 spuntatura								🪴✂️	🪴✂️	🪴✂️	🪴✂️	🪴✂️	🪴✂️	🪴✂️	🪴✂️	🪴✂️	🪴✂️	🪴✂️	🪴✂️	🪴✂️	🪴✂️	🪴✂️	🪴✂️	🪴✂️	🪴✂️	🪴✂️	🪴✂️	🪴✂️	🪴✂️						
Coltivazione di 3 talee con 1 spuntatura										🪴✂️	🪴✂️	🪴✂️	🪴✂️	🪴✂️	🪴✂️	🪴✂️	🪴✂️	🪴✂️	🪴✂️	🪴✂️	🪴✂️	🪴✂️	🪴✂️	🪴✂️	🪴✂️	🪴✂️	🪴✂️	🪴✂️	🪴✂️						
Coltivazione di 5 talee senza spuntatura														🪴	🪴	🪴	🪴	🪴	🪴	🪴	🪴	🪴	🪴	🪴	🪴	🪴	🪴	🪴	🪴	🪴					

🪴 **invaso**  
transplanting

🪴 **coltivazione**  
cultivation

✂️ **spuntatura**  
pinching

### NOTE

🧴 **Regolatore di crescita - Growth's regulator**

I regolatori di crescita possono essere utili su tutte le varietà, in particolare per le varietà che riportano il simbolo.  
Growth's regulators can be used in every variety, in particular for the varieties with the symbol.

✂️ ✂️ ✂️ **Cimature - Pinching**

Le ultime cimature devono essere effettuate entro le settimane 30-31.  
The last pinching must be done within week 30-31.





## LEGENDA

### Talea • Cutting • Cutting



normale  
normal  
normal



spuntata  
pinched  
écimé

### Pianta mezza coltura • Plant half-grown • Plant semi-finie



Ø cm 22



Ø cm 14



Ø cm 12

### Crescita • Growth • Croissance



compatta  
compact  
compacte



medio-compatta  
medium-compact  
moyen compacte



vigorosa  
vigorous  
vigoureuse

### Precocità • Precocity • Précocité



precoce  
early  
précoce



medio-precoce  
medium-early  
moyen précoce



tardiva  
late  
tardive

### Ramificazione • Branching • Ramification



scarsa  
poor  
maigre



normale  
normal  
normal



abbondante  
abundant  
abondant

### Regolatore di crescita • Growth's regulator • Régulateur de croissance



solo se necessario  
only if necessary  
seulement si  
nécessaire



utilizzo normale  
normal use  
normal emploi



uso veramente consigliato  
really suggested use  
emploi très conseillé

### Disponibile in colori separati • Available in separated colours Disponibile en couleurs séparés



intro  
intro  
intro



ordine minimo contenitori 3x60  
minimum order 3x60  
quantité minimum 3x60



Pianta svernata  
Plant with vernalisation  
Plant hivernée



---

HYDRANGEA  
MACROPHYLLA  
ORTENSIA

## RED COLOURS



CODICE	VARIETÀ	COLOUR	COLORE	TALEA NORMALE	TALEA SPUNTATA	MEZZA COLTURA Ø CM 22	MEZZA COLTURA Ø CM 14	MEZZA COLTURA Ø CM 12
08036	HERMANN DIENEMANN	red	rosso					
08056	RED BEAUTY	dark red	rosso scuro					
08139	ROYAL RED	dark red	rosso scuro					
08001	SCHÖNE BAUTZNERIN	red	rosso					



08036 HERMANN DIENEMANN

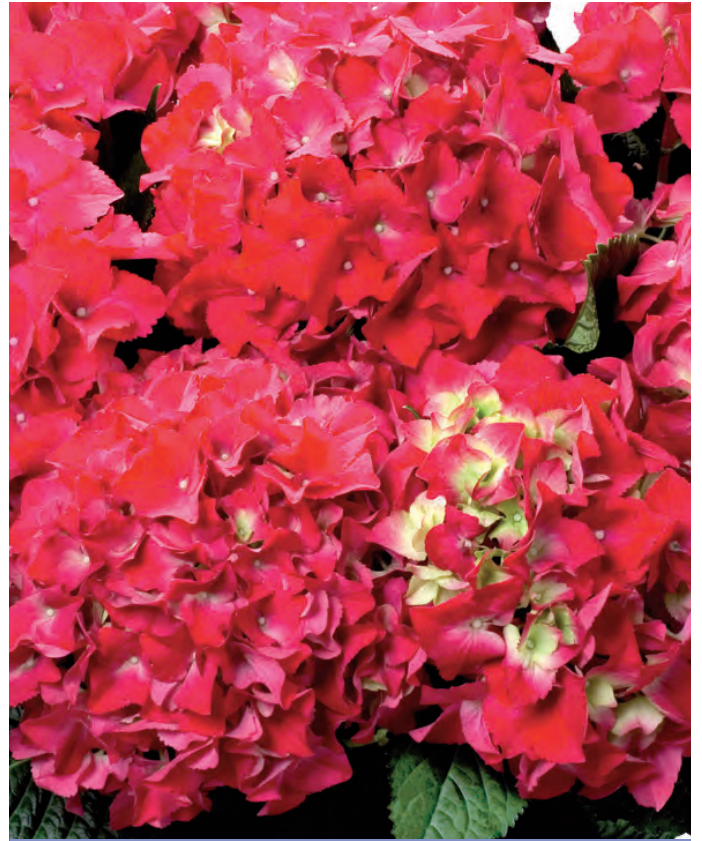

08056 RED BEAUTY



08139 ROYAL RED



08001 SCHÖNE BAUTZNERIN



## HYDRANGEA MACROPHYLLA - ORTENSIA

## BLUE COLOURS



CODICE	VARIETÀ	COLOUR	COLORE	TALEA NORMALE	TALEA SPUNTATA	MEZZA CULTURA Ø CM 22	MEZZA CULTURA Ø CM 14	MEZZA CULTURA Ø CM 12
08137	BABY BLUE	azurre	azzurro					
08080	BELA BLUE	blue	blu					
08099	EARLY® BLUE	azure / blue	azzurro / blu					
08169	JIP BLUE	blue	blu					
08189	MARINE	azure / blue	azzurro / blu					
08204	SARENA BLUE	blue	blu					



08137 BABY BLUE



08080 BELA BLUE



08099 EARLY® BLUE



08169 JIP BLUE



08189 MARINE



08204 SARENA BLUE

## ROSE COLOURS



CODICE	VARIETÀ	COLOUR	COLORE	TALEA NORMALE	TALEA SPUNTATA	MEZZA COLTURA Ø CM 22	MEZZA COLTURA Ø CM 14	MEZZA COLTURA Ø CM 12
08101	EARLY® ROSA / BLUE	rose	rosa					
08168	JIP ROSA / BLUE	rose	rosa					
08100	PINK SENSATION	rose	rosa					
08035	ROSITA	rose	rosa					
08211	SARENA PINK	pink	rosa					



08101 EARLY® ROSA / BLUE



08168 JIP ROSA / BLUE



08100 PINK SENSATION



08035 ROSITA



NEW

08211 SARENA PINK





SENTIER: HYDRANGEA MACROPHYLLA COLTIVAZIONE IN PIENO CAMPO - HYDRANGEA MACROPHYLLA CULTIVATED OUTDOOR

## WHITE COLOURS



CODICE	VARIETÀ	COLOUR	COLORE	TALEA NORMALE	TALEA SPUNTATA	MEZZA CULTURA Ø CM 22	MEZZA CULTURA Ø CM 14	MEZZA CULTURA Ø CM 12
08151	BIANCO	white	bianco					
08133	CLARISSA	white	bianco					
08049	SAXON® SCHNEEBALL	white	bianco					



08133 CLARISSA



08151 BIANCO



08049 SAXON® SCHNEEBALL

## HYDRANGEA MACROPHYLLA - ORTENSIA

## TELLER



CODICE	VARIETÀ	COLOUR	COLORE	ORDINE MINIMO	TALEA NORMALE	TALEA SPUNTATA	MEZZA COLTURA Ø CM 22	MEZZA COLTURA Ø CM 14	MEZZA COLTURA Ø CM 12
08154	FRISBEE® BLUE	blue	blu						
08182	FRISBEE® PETTICOAT	bicolour white w. pink edge	bicolore bianco con bordo rosa						
08153	FRISBEE® ROSA / BLUE	rose	rosa	★ 3 x 60					
08152	FRISBEE® WHITE	white	bianco	★ 3 x 60					
08157	TIFFANY LILA	lilac	lilla	★ 3 x 60					
08156	TIFFANY ROSA / LILA	rose	rosa	★ 3 x 60					



08154 FRISBEE® BLUE



08182 FRISBEE® PETTICOAT



08153 FRISBEE® ROSA / BLUE



08152 FRISBEE® WHITE



08157 TIFFANY LILA

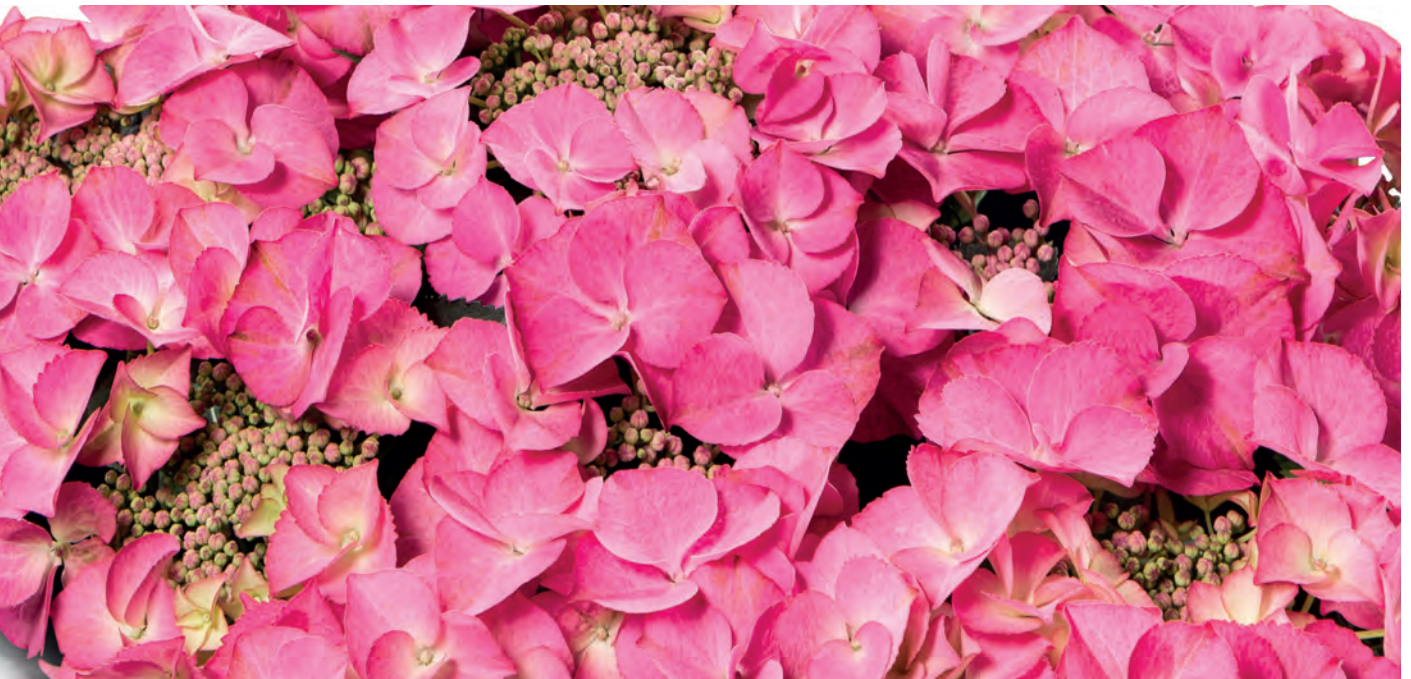

08156 TIFFANY ROSA / LILA

## HYDRANGEA MACROPHYLLA - ORTENSIA

## BICOLOUR



CODICE	VARIETÀ	COLOUR	COLORE	ORDINE MINIMO	TALEA NORMALE	TALEA SPUNTATA	MEZZA CULTURA Ø CM 22	MEZZA CULTURA Ø CM 14	MEZZA CULTURA Ø CM 12
08155	ADULA ROSA / LILA	bicolour dark pink w. dark pink edge	bicolore rosa chiaro con bordo rosa scuro	★ 3 x 60					
08201	SAXON® CANDY HEART BLUE	bicolour blue -white	bicolore blu - bianco						
08162	HOR TIVOLI BLUE	bicolour blue-white	bicolore blu-bianco						
08124	HOR TIVOLI PINK / BLUE	bicolour pink-white	bicolore rosa-bianco	★ 3 x 60					
08202	SAXON® CANDY HEART PINK/ BLUE	bicolour pink-white	bicolore rosa-bianco	★ 3 x 60					
08158	SAXON® GRAEFIN COSEL	bicolour pink-green	bicolore rosa-verde	★ 3 x 60					
08160	SAXON® SCHLOSS WACKERBARTH	bicolour pink-rose	bicolore rosa -verde	★ 3 x 60					



08155 ADULA ROSA / LILA



08124 HOR TIVOLI PINK / BLUE



08162 HOR TIVOLI BLUE



**08202** SAXON® CANDY HEART PINK / BLUE



**08201** SAXON® CANDY HEART BLUE



























































































































**08158** SAXON® GRAEFIN COSEL



**08160** SAXON® SCHLOSS WACKERBARTH



## ORTENSIA - HYDRANGEA MACROPHYLLA

CODICE	VARIETÀ	COLOUR	COLORE	CRESCITA	PRECOCITÀ	RAMIFICAZIONE	REGOLATORE DI CRESCITA
08036	HERMANN DIENEMANN	red	rosso				
08056	RED BEAUTY	dark red	rosso scuro				
08139	ROYAL RED	dark red	rosso scuro				
08001	SCHÖNE BAUTZNERIN	red	rosso				
08137	BABY BLUE	azurre	azzurro				
08080	BELA BLUE	blue	blu				
08099	EARLY® BLUE	azure / blue	azzurro / blu				
08169	JIP BLUE	blue	blu				
08189	MARINE	azure / blue	azzurro / blu				
08204	 SARENA BLUE	blue	blu				
08101	EARLY® ROSA / BLUE	rose	rosa				
08168	JIP ROSA / BLUE	rose	rosa				
08100	PINK SENSATION	rose	rosa				
08035	ROSITA	rose	rosa				
08211	 SARENA PINK	pink	rosa				
08151	BIANCO	white	bianco				
08133	CLARISSA	white	bianco				
08049	SAXON® SCHNEEBALL	white	bianco				
08154	FRISBEE® BLUE	blue	blu				
08182	 FRISBEE® PETTICOAT	bicolour white w. pink edge	bicolore bianco con bordo rosa				
08153	FRISBEE® ROSA / BLUE	rose	rosa				
08152	FRISBEE® WHITE	white	bianco				
08157	TIFFANY LILA	lilac	lilla				
08156	TIFFANY ROSA / LILA	rose	rosa				
08155	ADULA ROSA / LILA	bicolour dark pink w. dark pink edge	bicolore rosa chiaro con bordo rosa scuro				
08201	SAXON® CANDY HEART BLUE	bicolour blue -white	bicolore blu - bianco				
08162	HOR TIVOLI BLUE	bicolour blue-white	bicolore blu-bianco				
08124	HOR TIVOLI PINK / BLUE	bicolour pink-white	bicolore rosa-bianco				
08202	SAXON® CANDY HEART PINK / BLUE	bicolour pink-white	bicolore rosa-bianco				
08158	SAXON® GRAEFIN COSEL	bicolour pink-green	bicolore rosa-verde				
08160	SAXON® SCHLOSS WACKERBARTH	bicolour pink-rose	bicolore rosa -verde				





SENTIER: HYDRANGEA MACROPHYLLA COLTIVAZIONE IN PIENO CAMPO - HYDRANGEA MACROPHYLLA CULTIVATED OUTDOOR



## LEGENDA

Temperatura minima °C • Minimum temperature C° • Temperature minimum

---



Utilizzo • Use • Emploi

---



Ø cm 10-12



Ø cm 14-15



Ø cm 16



Ø cm 17-18

Foglia • Leaf • Feuillage

---



verde  
green  
vert



verde scuro  
dark green  
vert foncé



---

EUPHORBIA  
PULCHERRIMA  
POINSETTIA



## EUPHORBIA PULCHERRIMA - POINSETTIA



CODICE	VARIETÀ	COLOUR	COLORE	CRESCITA / SHAPE	FOGLIA	TEMP. MIN. C°	TEMPI DI REAZ. SETT.	TRAP. W 25-26	TRAP. W 27-29	TRAP. W 30-31	TRAP. W 32 -36
<b>29036</b>	sel® Christmas Aurora® NPCW14221	red	rosso	portamento a V		16	8,5	17-18	16	14-15	10-12
<b>29022</b>	sel® Christmas Beauty NPCW10158	red	rosso	portamento rotondo		16	8	17-18	16	14-15	10-12
<b>29048</b>	sel® Christmas Beauty Marble	rose/white bic.	rosa/ bianca bic.	portamento rotondo		16	8	17-18	16	14-15	10-12
<b>29042</b>	sel® Christmas Beauty Pink	rose	rosa	portamento rotondo		16	8	17-18	16	14-15	10-12
<b>29009</b>	sel® Christmas Feelings® NPCW02044	red	rosso	portamento a V		15	8	17-18	16	14-15	10-12
<b>29012</b>	sel® Christmas Feelings® White NPCW08119	white	bianco	portamento a V		15	8	17-18	16	14-15	10-12
<b>29025</b>	sel® Noel NPCW10167	red	rosso	portamento rotondo, vigoroso		15	7,5	17-18	16		



29048 SEL® CHRISTMAS BEAUTY MARBLE



29036 SEL® CHRISTMAS AURORA® NPCW 14221



29022 SEL® CHRISTMAS BEAUTY NPCW10158



29042 SEL® CHRISTMAS BEAUTY PINK



29009 SEL® CHRISTMAS FEELINGS® NPCW02044



29012 SEL® CHRISTMAS FEELINGS® WHITE NPCW08119



29025 SEL® NOEL NPCW10167

## EUPHORBIA PULCHERRIMA - POINSETTIA



CODICE	VARIETÀ	COLOUR	COLORE	CRESCITA / SHAPE	FOGLIA	TEMP. MIN. C°	TEMPI DI REAZ. SETT.	TRAP. W 25-26	TRAP. W 27-29	TRAP. W 30-31	TRAP. W 32 -36
29049	Lazzeri® Alaska® Lazppo1319	pure white	bianco puro	portamento vigoroso		16	8	17-18	16	14-15	10-12
29050	Lazzeri® Allegra® Red Lazppo1047	deep red	rosso intenso	portamento rotondo V aperta		15	8,5		16	14-15	10-12
29051	Lazzeri® Allegra® Pink	rose	rosa	portamento rotondo V aperta		15	8,5		16	14-15	10-12
29052	Lazzeri® Alpina® Lazppo1315	pure white	bianco puro	portamento medio compatto		16	7,5		16	14-15	10-12
29053	Lazzeri® Desiderio Red Lazppo1201	bright red	rosso brillante	portamento vigoroso		15	7	17-18	16	14-15	10-12
29054	Lazzeri® Futura Red Lazppo1078	deep red	rosso intenso	portamento ramificazione a V		15	8	17-18	16	14-15	10-12
29055	Lazzeri® Serena Red Lazppo1110	bright red	rosso brillante	portamento vigoroso a V		15	8	17-18	16	14-15	10-12
29056 <small>NEW</small>	Lazzeri® Superba Glitter Lazposugi	red/white bic.	rosso/ bianco bic.	portamento vigoroso a V		16	8	17-18	16	14-15	10-12



29049 LAZZERI® ALASKA® Lazppo1319



29050 LAZZERI® ALLEGRA® RED Lazppo1047



29051 LAZZERI® ALLEGRA® PINK



29052 LAZZERI® ALPINA® Lazppo1315

## POINSETTIA - EUPHORBIA PULCHERRIMA



29053 LAZZERI® DESIDERIO RED Lazzpo1201



29054 LAZZERI® FUTURA RED Lazzpo1078



29055 LAZZERI® SERENA RED Lazzpo1110



29056 LAZZERI® SUPERBA GLITTER Lazzposugi



CAMPO PROVA POINSETTIA - POINSETTIA TRIAL



## EUPHORBIA PULCHERRIMA - POINSETTIA



CODICE	VARIETÀ	COLOUR	COLORE	CRESCITA / SHAPE	FOGLIA	TEMP. MIN. C°	TEMPI DI REAZ. SETT.	TRAP. W 25-26	TRAP. W 27-29	TRAP. W 30-31	TRAP. W 32 -36
29057	Astro Red®	bright red	rosso brillante	Portamento a V		15	7,5	17-18	16	14-15	
29058	Hera Red®	bright red	rosso brillante	Portamento a V		15	8,5	17-18	16	14-15	
29059	Leona Red®	red	rosso	Portamento a V		15	7,5	17-18	16	14-15	
29060	Solar Red®	red	rosso			16	8		16	14-15	



29057 Astro Red®



29058 Hera Red®



29059 Leona Red®



29060 Solar Red®

## EUPHORBIA PULCHERRIMA - POINSETTIA



SENTIER: CAMPO PROVA POINSETTIA - POINSETTIA TRIAL



<b>2019</b>	Gennaio	Febbraio	Marzo	Aprile	Maggio	Giugno
<b>Domenica</b>						
Lunedì				1		
Martedì	<b>1</b> CAPODANNO			2		
Mercoledì	2 <b>1</b>	<b>5</b>	<b>9</b>	3 <b>14</b>	<b>1</b> F. LAVORO	<b>22</b>
Giovedì	3 si consegna			4	2 <b>18</b>	
Venerdì	4	1	1	5	3	
Sabato	5	2	2	6	4	1
<b>Domenica</b>	<b>6</b> EPIFANIA	<b>3</b>	<b>3</b>	<b>7</b>	<b>5</b>	<b>2</b> F. REPUBBLICA
Lunedì	7	4	4	8	6	3
Martedì	8	5	5	9	7	4
Mercoledì	9 <b>2</b>	6 <b>6</b>	6 <b>10</b>	10 <b>15</b>	8 <b>19</b>	5 <b>23</b>
Giovedì	10	7	7	11	9	6
Venerdì	11	8	8	12	10	7
Sabato	12	9	9	13	11	8
<b>Domenica</b>	<b>13</b>	<b>10</b>	<b>10</b>	<b>14</b>	<b>12</b> F. MAMMA	<b>9</b>
Lunedì	14	11	11	15	13	10
Martedì	15	12 <b>7</b>	12	16	14	<b>11</b>
Mercoledì	16 <b>3</b>	13	13 <b>11</b>	17 <b>16</b>	15 <b>20</b>	<b>12</b>
Giovedì	17	<b>14</b> S. VALENTINO	14	18	16 <b>20</b>	<b>13</b>
Venerdì	18	15	15	19	17	<b>14</b>
Sabato	19	16	16	20	18	15
<b>Domenica</b>	<b>20</b>	<b>17</b>	<b>17</b>	<b>21</b> PASQUA	<b>19</b>	<b>16</b>
Lunedì	21	18	18	<b>22</b> DELL'ANGELO	20	17
Martedì	<b>22</b> IPM - Essen	19	<b>19</b> FESTA PAPÀ	23	21	18
Mercoledì	23 <b>4</b>	<b>20</b> MY PLANT & GARDEN Milano	20 <b>12</b>	24 <b>17</b>	22 <b>21</b>	19 <b>25</b>
Giovedì	24	21	21	<b>25</b> LIBERAZIONE	23	20
Venerdì	25	22	22	26	24	21
Sabato	26	23	23	27	25	22
<b>Domenica</b>	<b>27</b>	<b>24</b>	<b>24</b>	<b>28</b>	<b>26</b>	<b>23</b>
Lunedì	28	25	25	29	27	24
Martedì	29	26	26	30	28	25
Mercoledì	30 <b>5</b>	27 <b>9</b>	27 <b>13</b>	<b>18</b>	29 <b>22</b>	26 <b>26</b>
Giovedì	31	28	28		30	27
Venerdì			29		31	28
Sabato			30			29
<b>Domenica</b>			<b>31</b>			<b>30</b>
Lunedì						
Martedì						



<b>2019</b>	Luglio	Agosto	Settembre	Ottobre	Novembre	Dicembre	
<b>Domenica</b>							
Lunedì	1						
Martedì	2			1	44		
Mercoledì	3	27	31	35	40	48	
Giovedì	4	1		3			
Venerdì	5	2		4	1 OGNISSANTI		
Sabato	6	3		5	2		
<b>Domenica</b>	7	4	1	6	3	1	
Lunedì	8	5	2	7	4	2	
Martedì	9	6	3	8	5	3	
Mercoledì	10	28	7	36	9	4	49
Giovedì	11	8	5	10	41	6	5
Venerdì	12	9	6	11	7	8	6
Sabato	13	10	7	12	8	9	7
<b>Domenica</b>	14	11	8	13	10	8 IMMACOLATA	
Lunedì	15	12	9	14	11	9	
Martedì	16	13	10	15	12	10	
Mercoledì	17	14	33	16	13	11	50
Giovedì	18	29	15 ASSUN. M.V.	17	14	12	12
Venerdì	19	16	no consegne	18	15	13	13
Sabato	20	17	14	19	16	14	
<b>Domenica</b>	21	18	15	20	17	15	
Lunedì	22	19	16	21	18	16	
Martedì	23	20	17	22	19	17	
Mercoledì	24	30	21	23	20	18	51
Giovedì	25	34	18	24	21	19	
Venerdì	26	22	19	25	22	20	
Sabato	27	23	20	26	23	21	
<b>Domenica</b>	28	24	21	27	24	22	
Lunedì	29	25	22	28	25	23	
Martedì	30	26	23	29	26	24	52
Mercoledì	31	27	24	30	27	25 NATALE	
Giovedì		28	25	31	28	26 S. STEFANO	
Venerdì		29	26		29	27	no consegne
Sabato		30	27		30	28	
<b>Domenica</b>		31	28			29	
Lunedì			29			30	1
Martedì			30			31	



  
*Sentier*

esportazione prodotti in:

export plants in:

- Austria
- Bulgaria
- Croazia
- Francia
- Germania
- Grecia
- Olanda
- Macedonia
- Malta
- Polonia
- Romania
- Slovacchia
- Slovenia
- Spagna
- Ungheria

...in continua espansione  
... and keep growing





## INDEX - INDICE

<b>CYCLAMEN PERSICUM - BIG FLOWER - THE TWIN</b>	<b>20</b>
MAXI TWIN	20
RIVIERA F1	22
CHARISMA F1	23
PRINCE F1 (FRINGED) FRANGIATI	25
FORMULA HD	26
HALIOS® F1	29
HALIOS® F1 FANTASIA®	32
HALIOS® F1 CURLY® FRINGED (FRANGIATI)	34
LATINIA® F1	36
LATINIA® F1 SUCCESS®	37
LATINIA® F1 FANTASIA®	39
MAGNIA	40
SUPER SERIE® MAMMOTH® F1	42
SUPER SERIE® XL® F1	44
SUPER SERIE® XL® F1 FUJI	46
WINTER ICE™ F1	46
SNOWRIDGE MAXI F1	47
<b>CYCLAMEN PERSICUM - MIDI FLOWER</b>	<b>50</b>
INDIAKA®	50
PREMIUM F1	50
SUPER SERIE® ALLURE® F1	51
SUPER SERIE® ALLURE® F1 FUJI	53
SUPER SERIE® MACRO F1	54
SUPER SERIE® MACRO F1 FUJI	55
SUPER SERIE® REMBRANDT® F1	56
TIANIS® F1	56
TIANIS® F1 FANTASIA®	58
<b>CYCLAMEN PERSICUM - MINI FLOWER</b>	<b>62</b>
METIS® F1	62
METIS® F1 DECORA	64
METIS® F1 FANTASIA®	64
METIS® F1 VICTORIA MINI	65
SMARTIZ® F1 MINI	66
SMARTIZ® F1 FANTASIA®	67
SUPER SERIE® CARINO® F1	68
SUPER SERIE® CARINO® F1 FUJI	70
SUPER SERIE® COMPACT F1	71
SUPER SERIE® COMPACT F1 FUJI	73
SUPER SERIE® DONATELLO® F1	74
SUPER SERIE® PICASSO® F1	76
SUPER SERIE® VERANO® F1	78
SUPER SERIE® VERANO® F1 FUJI	81
SUPER SERIE® MINI WINTER® F1	82
SUPER SERIE® MINI WINTER® F1 FUJI	84
SUPER SERIE® JIVE® F1 (FRINGED) FRANGIATI	84
<b>ASTER NOVI-BELGII</b>	<b>88</b>
SHOWMAKERS® SERIES	88
TIARA® SERIES	89
<b>CELOSIA ARGENTEA</b>	<b>92</b>
FLIRT® SERIES	92
HOT TOPIC® SERIES	93

MERIDA®	93
<b>CHRYSANTHEMUM - CRISANTEMO</b>	<b>98</b>
SETTEMBRINI GROUP - FLOWERING WEEK 38	98
PADRE GROUP - FLOWERING WEEK 39	99
AMIKO GROUP - FLOWERING WEEK 41	100
ALUGA-VERITAS GROUP - FLOWERING WEEK 41	101
TOCCA GROUP - FLOWERING WEEK 42	102
STAVISKI GROUP - FLOWERING WEEK 42	103
OTHER VARIETIES - FLOWERING WEEK 42	104
MEFISTO GROUP - FLOWERING WEEK 43	105
GUARINI GROUP - FLOWERING WEEK 43	106
VIGORELLI GROUP - FLOWERING WEEK 43	107
MURANO GROUP AND OTHER VARIETIES - FLOWERING WEEK 43	108
TRIOCRYSO	110
BIG FLOWER	114
SAMOURAI SERIES	117
SPECIAL FLOWER	118
<b>HYDRANGEA MACROPHYLLA - ORTENSIA</b>	<b>122</b>
RED COLOURS	122
BLUE COLOURS	124
ROSE COLOURS	126
WHITE COLOURS	129
TELLER	130
BICOLOUR	132
<b>EUPHORBIA PULCHERRIMA - POINSETTIA</b>	<b>140</b>









Via Sentier, 34  
31010 Mosnigo di Moriago della Battaglia  
TREVISO - ITALY  
tel. +39.0438.892456 r.a.  
fax +39.0438.892662

**info@sentier.it**  
**www.sentier.it**

Seguici su 